

Other Test Method – 30: Method to Quantify Particulate Matter Emissions from Windblown Dust

This method is designed to quantify particulate matter (PM) emissions from open areas susceptible to wind erosion where saltation flux can be measured. This method was submitted by the Great Basin Unified Air Pollution Control District (GBUAPCD) to EPA's Office of Air Quality, Planning and Standards – Air Quality Assessment Division – Measurement Technology Group (MTG) for inclusion into the Other Test Method (OTM) category on EPA's Emission Monitoring Center (EMC) website at <http://www.epa.gov/ttn/emc/tmethods.html#CatC/>. The posting of a test method on the OTM portion of the EMC is neither an endorsement by EPA regarding the validity of the test method nor a regulatory approval of the test method. The purpose of the OTM portion of the EMC is to promote discussion of developing emission measurement methodologies and to provide regulatory agencies, the regulated community, and the public at large with potentially helpful tools.

Other Test Methods are test methods which have not yet been subject to the *Federal rulemaking process*. Each of these methods, as well as the available technical documentation supporting them, have been reviewed by the Emission Measurement Center staff and have been found to be potentially useful to the emission measurement community. The types of technical information reviewed include field and laboratory validation studies; results of collaborative testing; articles from peer-reviewed journals; peer-review comments; and quality assurance (QA) and quality control (QC) procedures in the method itself. A table summarizing the available technical information for each method can be found at the link below. The EPA strongly encourages the submission of additional supporting field and laboratory data as well as comments in regard to these methods.

These methods may be considered for use in Federally enforceable State and local programs (e.g., Title V permits, State Implementation Plans (SIP)) provided they are subject to an EPA Regional SIP approval process or permit veto opportunity and public notice with the opportunity for comment. The methods may also be considered to be candidates to be alternative methods to meet Federal requirements under 40 CFR Parts 60, 61, and 63. However, they must be approved as alternatives under 60.8, 61.13, or 63.7(f) before a source may use them for this purpose. Consideration of a method's applicability for a particular purpose should be based on the stated applicability as well as the supporting technical information outlined in the table. The methods are available for application without EPA oversight for other non-EPA program uses including state permitting programs and scientific and engineering applications.

As many of these methods are submitted by parties outside the Agency, the EPA staff may not necessarily be the technical experts on these methods. Therefore, technical support from EPA for these methods is limited, but the table contains contact information for the developers so that you may contact them directly. Also, be aware that these methods are subject to change based on the review of additional validation studies or on public comment as a part of adoption as a Federal test method, the Title V permitting process, or inclusion in a SIP.

Method Revision History

Revision 1 – 3/22/2012

Revision 2 – 6/20/2012 – Received comments from the Los Angeles Department of Water and Power (LADWP); after review of these comments and additional supporting information, OTM -30 has been revised to include the LADWP comments (Appendix E), a GBUAPCD response to these comments (Appendix F), and an Expert Panel Report on the use of the Dust ID Model used in OTM-30 (Appendix G).

EMC advises all potential users to review the method and all appendices before application of this method.

Method to Quantify Particulate Matter Emissions from Windblown Dust

1.0 Scope and Application

1.1. *Introduction.* The windblown dust emissions test method is designed to quantify particulate matter (PM) emissions from open areas susceptible to wind erosion. The method relies on comparing saltation flux to the difference in upwind and downwind ambient PM concentrations to quantify PM emissions. Saltation flux is a measurement of the mass of windblown sand and sand-sized particles that pass horizontally through a vertical plane. Saltation flux is measured in units of mass/area as opposed to PM concentration which has units of mass/volume. Experimental evidence has shown that the ratio of saltation flux to PM emissions can be characterized for a given surface for a given time. This ratio can be used with saltation flux measurements and dispersion modeling to calculate PM emissions by comparing model predictions to measured ambient PM concentrations.^{1,2}

1.2. *Applicability.* This method can be applied to any open surface area susceptible to wind erosion where saltation flux can be measured. Depending on the type of ambient PM monitoring used, PM emissions can be quantified as particulate matter less than 2.5 microns (PM_{2.5}), less than 10 microns (PM₁₀), or the coarse fraction of PM₁₀ (PM_{10-2.5}).

1.3. *Data Quality Objectives (DQOs).* Data quality objectives define the appropriate data to collect, the conditions under which to collect the data, and the criteria for data acceptability for each project. Although DQOs are project specific, some general DQOs apply to all projects conducted to quantify the particulate matter contained in windblown dust. These DQOs include population uncertainties and measurement uncertainties. Population uncertainties include network representativeness, or the degree to which the data collected accurately and precisely represent, in this case, pollutant impacts on a population. Uncertainty in this arena can be controlled through the selection of appropriate boundary conditions, such as, the monitoring area, the number and location of sampling sites, the sampling time period, and the frequency of sampling. Measurement uncertainties include errors associated with the measurements themselves and with the handling and processing of the samples. A quality assurance program is used to control and quantify measurement uncertainty to an acceptable level through the use of various quality control and evaluation techniques. The data quality indicators most important in determining total measurement uncertainty are: precision, accuracy, bias, and detection limits. These indicators are specifically defined by measurement quality objectives that, in turn, specifically define criteria for each variable affecting these data quality indicators.

1.4. *Measurement Quality Objectives (MQOs).* The measurement quality objectives (MQOs) set the limits of certain variables affecting the data that will determine data acceptability. The United States Environmental Protection Agency (US EPA) has developed MQOs for a number of variables affecting data quality, which are found in the US EPA guidance documents.^{14, 15} These variables for which MQOs have been developed include those for precision, accuracy, bias, etc. Additional and/or more stringent MQOs may need to be developed for a given project over and above those established by the US EPA in order to achieve the data quality objectives for a project. The MQOs established by the US EPA apply most specifically to long-term ambient monitoring programs. Test method studies that are short-term in comparison with routine long-term ambient monitoring programs will likely require additional and more stringent MQOs, e.g. 90% data capture rates for all monitored variables rather than the 75% rate per quarter required by the US EPA for 24-hour daily average PM monitoring. Wind storm driven particulate emissions monitoring will require hourly data in order to characterize dust sources

and hourly data capture rates must be developed for associated measurement quality objectives. More generalized quality assurance protocols for ambient PM monitoring data collection are also found in the regulatory guidelines (40 CFR, Part 58).

Meteorological data is used to support the dispersion model and to evaluate the relationship between saltation flux (also referred to as sand flux in this document) and PM impacts. Dispersion modeling is conducted using federally-approved models in accordance with Title 40 CFR, Part 51, Appendix W. Specific data quality objectives for sand flux measurements are suggested based on previous studies, but must be tailored to the specific application by the user depending on the type of sand flux measurement device that is used.

Appendix A includes a list of required and optional PM, meteorological and sand flux measurements needed to apply the windblown dust OTM. In Appendix B, the MQOs for each of the measurement parameters needed for the OTM are listed for PM, meteorological and sand flux monitoring. Most MQOs follow US EPA guidance for ambient measurement parameters. Appendix C contains the MQOs for sand flux monitoring, which is not a routine measurement used in air monitoring programs.

2.0 Summary of Method

2.1. *Principle.* During wind erosion events sand-sized particles creep and saltate across the surface, and finer dust particles are lofted. These events can cause dust to be transported many kilometers downwind. This test method can be applied to determine dust emissions as PM₁₀, PM_{10-2.5}, or PM_{2.5}. Because saltating particles move relatively short distances during a wind event, measurements of horizontal sand flux indicate the amount of wind erosion taking place near measurement sites. This test method is based on theoretical and experimental evidence that the vertical flux of dust is proportional to the horizontal flux of sand-sized particles. A schematic drawing of the saltation and dust production process is shown in Figure 1.

2.2. *History of the Methodology.* Shao, et al.,³ theorized that the ratio of vertical dust emissions to horizontal sand flux tends to be constant for soils with the same binding energy. However, the binding energy of soils with similar texture and chemistry changes if surface moisture and temperature cause the soil to become more erodible or to form a crust and become stable. Long-term wind erosion studies at Owens Lake (1999-2010)^{1,4} and Mono Lake (2009-10)² in California found that the ratio of dust emissions to sand flux changed seasonally for given surfaces. These studies compared hourly sand flux to the difference between upwind and downwind PM₁₀ concentrations using dispersion models to determine changes in the seasonal ratio of dust emissions to sand flux. The hourly and seasonal ratios of the vertical flux of PM₁₀ to horizontal sand flux were termed K-factors, K_f . These K-factors were used with sand flux measurements to calculate the vertical PM₁₀ emission flux, F [g/cm²-s], using Equation 1 as follows:

(1)

where q_{15} [g/cm²-s] is the horizontal sand flux passing through a square centimeter plane at 15 cm above the surface, and K_f is a non-dimensional proportionality constant that is calculated from a dispersion model. Note that size-specific K-factors can be calculated for PM₁₀, PM_{10-2.5} or PM_{2.5}, depending on the type of particulate monitor used for PM measurements. These studies also found that different soil textures and chemistries can affect K-factors. This resulted

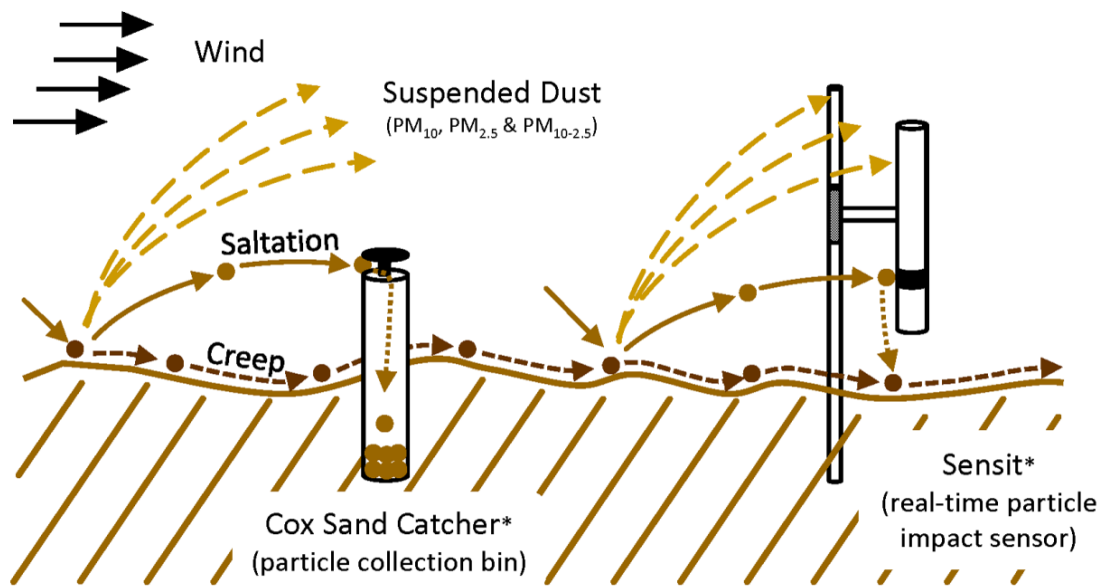

*Typical sampling height is 15 cm for saltating particles

Figure 1. Schematic drawing of the saltation and dust production process for windblown dust.

in developing K-factors for different areas based on soil characteristics. This improved the estimated PM_{10} emissions by applying both spatial and temporal K-factors to Equation 1.^{1,2,4}

2.3. *Sand Flux Measurements.* This test method requires two instruments to measure sand flux; one to measure the total sand catch during a collection period (e.g. month) and another to time-resolve the sand catch over the sampling period to determine the hourly sand flux. Cox Sand Catchers (CSCs) and Sensits, or equivalent instrument(s) capable of time resolving sand flux are required for use with this test method. The optional use of other sand flux measurement instruments, such as the BSNE (Big Springs Number Eight) is discussed in Section 13 of this document.

2.3.1. Cox Sand Catchers (CSCs) are manufactured by the Great Basin Unified Air Pollution Control District in Bishop, California and have been used extensively with this test method to measure sand catch. The inlets are placed at a 15 cm height above the surface in the dust source area. Sample tubes are collected about once a month for weighing in the laboratory.

2.3.2. Sensits are manufactured by the Sensit Company in Portland, North Dakota.⁵ They are the only instrument that have been used successfully with this method to time-resolve hourly sand flux. Sensits use a piezoelectric crystal similar to a microphone to continuously detect and measure saltation activity as particle count and kinetic energy. These Sensit readings are proportional to the mass flux of particles. Sensits are co-located with CSCs, which measure the mass sand flux over long periods of time, such as weeks or months. Hourly Sensit readings are then used to time-resolve the CSC sand catch for the sampling period to determine hourly sand flux. Because horizontal sand flux decreases with height above the surface it is important that CSC and Sensit measurements be taken at the same height at all locations to ensure consistency in the results. It is recommended that the sensor of the Sensit and CSC inlet both be centered 15 cm above the surface.

2.4. **Particulate Matter Monitoring.** Federally-approved ambient particulate matter monitors capable of collecting hourly data are required for this test method. The US EPA maintains a list of designated reference and equivalent method monitors on their website at <http://www.epa.gov/ttnamti1/criteria.html>.⁵ Studies using this method^{1,2,4} have used TEOM PM₁₀ monitors with good success (method number EQMP-1090-079). Other federally approved monitors capable of measuring hourly PM concentrations should also work with this method. This could include beta-gauge and beta attenuation type monitors or others that are capable of measuring hourly concentrations for PM₁₀, PM_{10-2.5} or PM_{2.5}.⁵

2.5. **Meteorological Monitoring.** A 5 to 10-m meteorological tower is required for this test method. The meteorological tower should be located near the study area and equipped to measure and record hourly average data for scalar wind speed and direction as well as sigma-theta. Vector wind speed data is not required for the model inputs for this method. Other optional meteorological parameters such as solar radiation, precipitation and temperature may be measured. The tower should be sited and the data collected in accordance with federal monitoring guidelines as described in US EPA Volume IV.¹⁵

2.6. **Dispersion Modeling.** The AERMOD or CALPUFF dispersion models are US EPA-approved models that are used to support air quality analysis for new sources and State Implementation Plans in the US. Both dispersion models have worked well with this test method. Dispersion models are applied following US EPA modeling guidance (40 CFR, Part 51, Appendix W). AERMOD is a steady-state plume dispersion model suitable for smaller modeling domains, while CALPUFF is commonly applied to near-field dispersion and long-range transport situations where the three-dimensional qualities of the wind field are important.

2.7. **K-factors.** The dispersion model is used to calculate K_f using PM emissions from Equation 1 assuming an initial K-factor, $K_i = 5 \times 10^{-5}$, which has been determined to be a good initial K-factor value that typically range from 1×10^{-5} to 10×10^{-5} for loose sandy soils.¹ Hourly K-factor values are then refined in a post-processing step to determine the K-factor value that would have made the hourly modeled concentration, C_m , match the observed hourly concentration, C_o , minus background, C_b using Equation 2 as follows:

$$\text{—————} \tag{2}$$

K-factors are calculated for every hour with active sand flux in areas upwind of a PM monitor. Hourly K-factors are screened to remove hours that do not have strong source-receptor relationships between the active dust source area and the downwind PM monitor. Screening criteria exclude hours for K-factor calculation when the dust plume misses the PM monitor, as well as hours when the monitor is near the edge of a dust plume. Because the edge of a dust plume has a very high concentration gradient, a few degrees difference in the plume direction could greatly affect a calculated K-factor. Examples of K-factor screening criteria include: hourly modeled and monitored PM₁₀ are both greater than $150 \mu\text{g}/\text{m}^3$, and sand flux is greater than $2 \text{ g}/\text{cm}^2\text{-hr}$ in at least one sand flux site that was located within $\pm 15^\circ$ upwind from a monitor site. The $\pm 15^\circ$ wind direction screen from the sand flux site to the PM monitor site provides a 30° wind direction cone that helps to account for lateral plume dispersion as the dust travels downwind toward the monitor. These screening criteria may be modified by the user to ensure that enough hourly K-factors pass the screening criteria to yield reasonable results. For instance, in areas that have less wind erosion activity the screening criteria might be lowered to hourly modeled and monitored PM₁₀ are both greater than $50 \mu\text{g}/\text{m}^3$, and sand flux is greater than 0.1

g/cm²-hr in at least one sand flux site. This will allow more data to be used to calculate hourly K-factors.

2.8. *PM emission determination.* The final step in the test method is to calculate seasonal K-factors using the screened hourly K-factors. These K-factors are based on the geometric mean hourly K-factor for a user-defined period or season. The geometric mean is appropriate for this purpose because the hourly K-factors tend to follow a log-normal distribution curve. Seasonal K-factors are used with Equation 1 to estimate hourly PM emissions. The framework of the windblown dust emissions test method is shown as a process flow diagram in Figure 2.

3.0 Definitions

3.1. Dust refers to particulate matter (PM) less than 10 microns (PM₁₀), less than 2.5 microns (PM_{2.5}), and coarse particles (PM_{10-2.5}).

3.2. Emission flux refers to the upwardly directed PM mass in terms of mass per area.

3.3. K-factor refers to the ratio of the vertical dust flux to the horizontal saltation flux.

3.4. Saltation refers to the wind-activated hopping and skipping movement of sand-sized particles above the soil surface.

3.5. Sand flux refers to the amount of sand-sized particles passing perpendicular through a vertical plane; also referred to as saltation flux. Sand-sized particles include individual sand grains as well as agglomerated soil particles.

3.6. Sand catcher refers to devices, such as the Cox Sand Catcher that are used to measure saltation flux over a given period (e.g. monthly sample collection).

3.7. Sensit refers to an electronic sensor that provides a relative reading of the sand flux over time. It is used to time-resolve sand catch mass using the linear relationship between Sensit readings and saltation flux to determine hourly sand flux rates.⁶

4.0 Interferences

4.1. *Unmonitored Sources of PM.* Dust sources that are not included in the background concentration as measured at the upwind monitor or not included in the model may bias hourly K-factors. This could include adjacent dust source areas that are not included in the sand flux monitoring area and miss the upwind monitor, but impact the downwind monitor site. Since the accuracy of K-factors in Equation 2 relies on good model predictions that correlate with PM monitor concentrations at the downwind site, it is important that all PM sources that contribute to downwind monitor concentrations are included in the dispersion model. If sources other than windblown dust are contributing to downwind PM concentrations, they can be included in the background concentration if they are much smaller than the contribution from the monitored windblown dust source areas (e.g. less than 20% of the total ambient PM impact), or included as separate PM sources in the dispersion model.

4.2. *Non-representative Winds.* The meteorological tower and PM monitor should be located to avoid any structures or topographical features that may interfere with wind flow patterns between the dust source area and the downwind PM monitor.

4.3. *Weak Source-Receptor Relationships.* The source-receptor relationship is the link between the source of PM emissions at the sand flux measurement sites and the impact at the

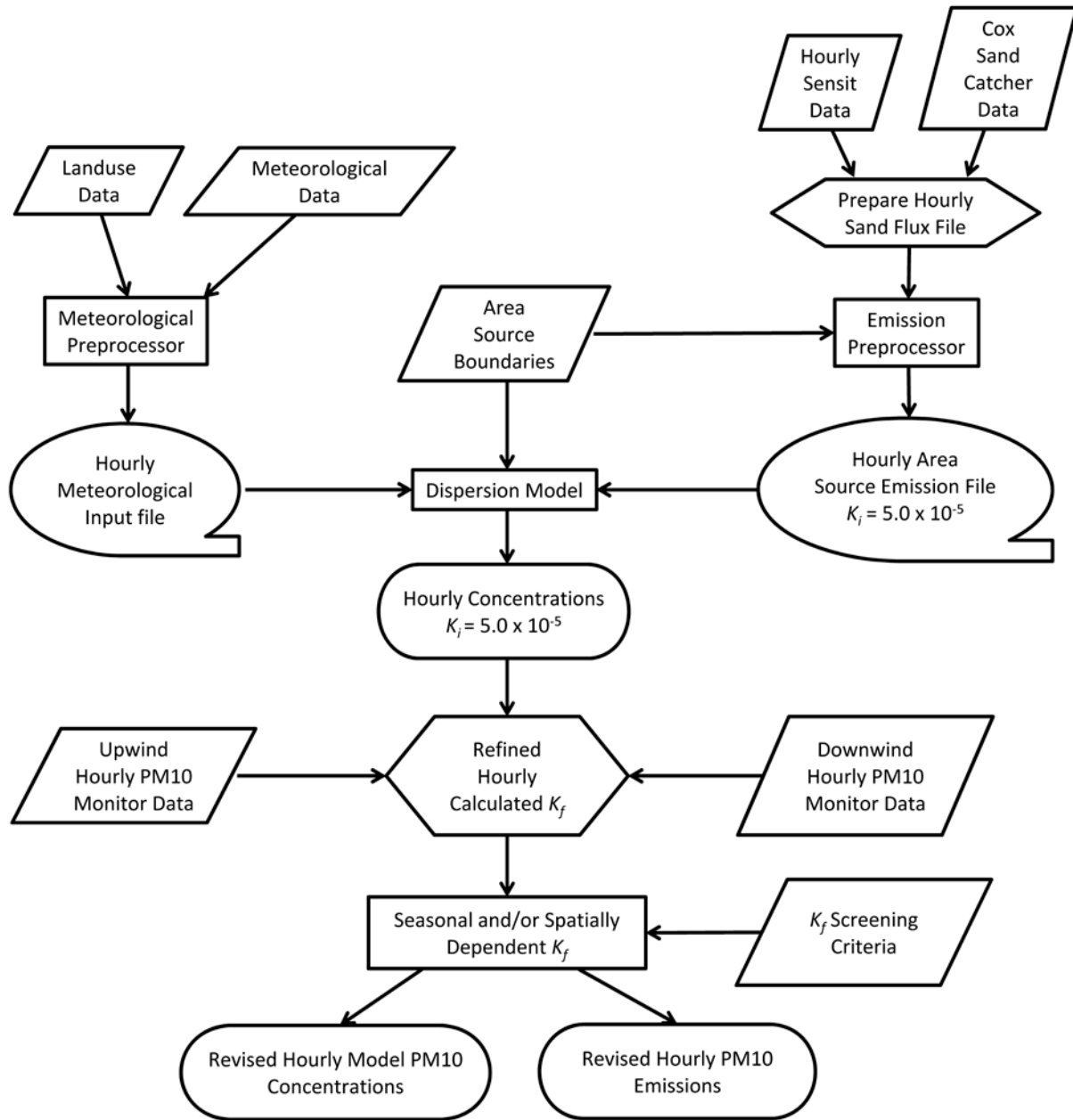

Figure 2. Process flow diagram for the windblown dust test method.

model receptor location identified as the downwind ambient PM monitor site. The screening of hourly K-factors for wind direction, source strength and monitored impact is intended to focus the hourly K-factors on the values that have the strongest source-receptor relationship. The screening criteria are left to the user to decide. See Section 2.7 for examples of K-factor screening criteria. Because some areas may have smaller source areas or lower PM concentrations, overly restrictive screening could result in no usable results. After the K-factors are determined, the best way to evaluate the validity of the emission estimates for the dust source areas is to utilize the new values using Equation 1 in the dispersion model and compare model predictions to monitored concentrations.

5.0 Safety

5.1. *PM Exposure.* As a health precaution, project personnel should avoid exposure to high PM. Windblown dust source areas can have hourly PM₁₀ levels exceeding 10,000 µg/m³ during a high wind event. All of the monitoring equipment is intended to be left in place during an event and should require no site visits except for routine maintenance for the PM monitor and monthly visits to the sand flux sites to collect sample tubes and to download Sensit data. These site visits should be done when wind speeds are below the threshold to generate dust.

5.2. *Let someone know where you are going if you will be in a remote location.* If projects are conducted in remote locations, field personnel should let someone know where they will be going and when they expect to return. Project sites can be in locations with no cell phone reception. Personnel may require assistance in the case of an emergency, such as having a vehicle breakdown or getting stuck in the sand.

6.0 Equipment and Supplies

6.1. *Sand Flux Sample Collection.* Figure 3 shows an example of a CSC and Sensit sampling site at Mono Lake, CA.

6.1.1. *Cox Sand Catchers & Sampling Tubes* – The number of CSCs to be deployed will vary with the size and surface uniformity of the study area. Replacement sampling tubes will be needed for each CSC site. CSCs should be installed using an auger to drill a hole in the soil to fit the CSC sample tube casing. In sandy soil it is helpful to wet the soil in the upper portion of the hole before drilling to avoid soil collapse. CSCs can be obtained from the Great Basin Unified Air Pollution Control District in Bishop, California or the design specifications provided in Figure 4 can be used to construct your own CSCs.

6.1.2. *Sensits* – The number of Sensits to be deployed will vary with the size and uniformity of the surface in the study area. All Sensits must be collocated with CSCs, however, to reduce equipment costs and to increase spatial sand flux information, Sensits may be used to time-resolve sand flux for multiple nearby CSC sites that have no Sensits. Each Sensit must have a support structure to suspend the sensor at 15 cm above the surface. The support structure should be positioned so it doesn't interfere with saltation particles moving in the directions for expected high winds. Information on installing and operating Sensits can be found at <http://sensit.org/default.aspx>.⁶

6.1.3. *Data Loggers* – Each Sensit site must have a data logger to record time, kinetic energy and particle count readings from the Sensits. This data is stored in 5-minute and hourly increments. Other useful data includes voltage for the power supply.

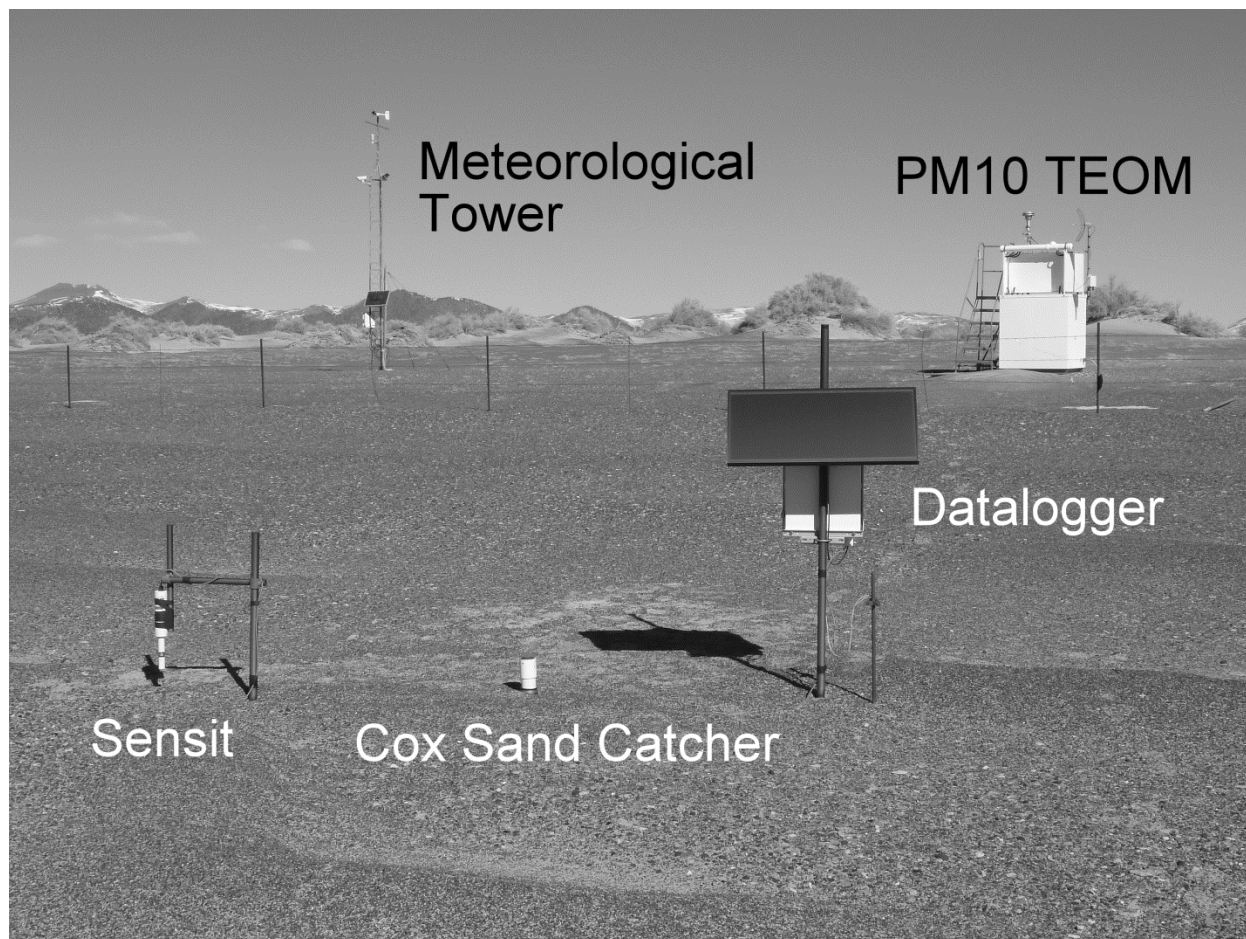

Figure 3. Sand flux site and dust monitoring equipment at Mono Lake, CA.

6.1.4. Power Supply; battery & solar panel – Each Sensit site must have a power supply for the data logger and Sensit. Solar panels with 20 amp-hr batteries are generally used to provide power at Sensit sites.

6.1.5. Height Adjustment Tool - A small tripod with flat feet (Figure 5) is used to measure the height of the CSC inlet and the sensor ring of the Sensit after each collection period and if necessary, to readjust the center of the CSC inlet and Sensit sensor ring to 15 cm above the surface at the start of the next collection period.

6.1.6. Field Scale – A scale capable of measuring mass up to 2 kg is used to obtain approximate CSC sample tube collection weights to the nearest 1 gram in the field.

6.2. Sample Recovery

6.2.1. Balance – A balance capable of measuring mass to ± 0.1 g is needed to weigh CSC samples in the lab. The tare weight of the CSC collection tube and sample may be as much as 2,000 g. Large samples may have to be split to obtain total weights.

Oven, drying pans & distilled water – Wet or moist CSC samples must be transferred from the collection tube to a pan and dried in the oven to obtain a dry sand catch mass. Distilled water is used to wash the sample from the tubes.

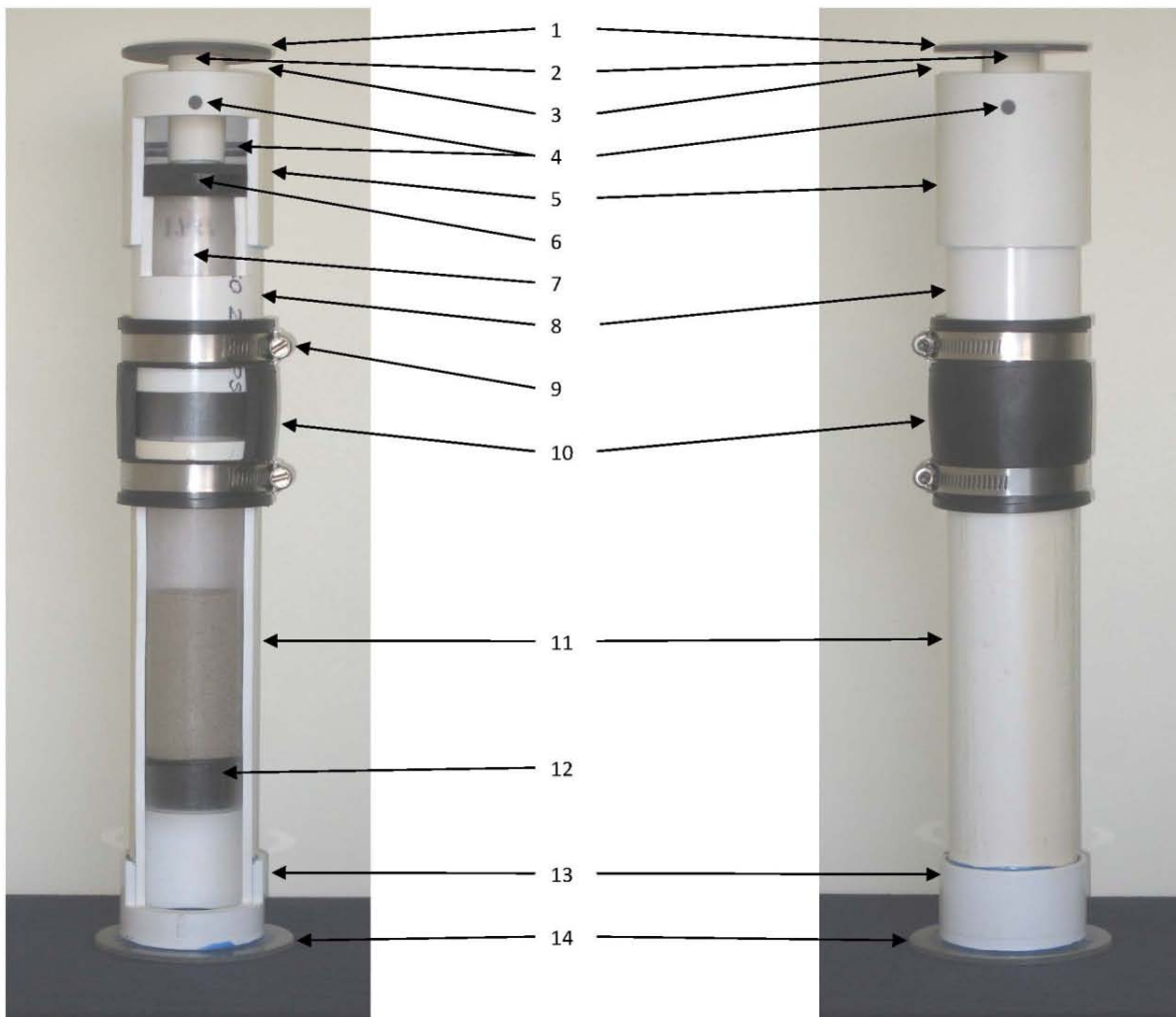

Reference #	Feature	Description
1	Roof	1/8" thick by 2 3/4" diameter PVC sheet
2	Roof Support	3/4" schedule 40 PVC pipe 2" in length
3	Sample Inlet Opening	1 cm from bottom of roof to top of PVC coupling. Tolerance is 0.5 mm.
4	Support Pins	1/4" diameter PVC rod glued in place
5	Head	2" schedule 40 PVC coupling, specify long coupling approximately 2 3/4" in length
6	Catch Tube Seal	rubber shank washer cut to fit
7	Catch Tube	2" diameter clear plastic soil sample tube variable length to fit application*
8	Connecting Pipe	2" schedule 40 PVC pipe** 3 1/2" in length
9	Stainless Pipe Clamp	
10	Adjustment Coupling	2" diameter rubber plain and flexible pipe coupling 3 1/2" in length
11	Body	2" schedule 40 PVC pipe** variable in length to fit application, 25" for 2' CSC
12	Catch Tube Stopper	rubber stopper or plug
13	Bottom Cap	2" schedule 40 PVC cap with a flat top
14	Bottom Plate	1/8" thick by 3 7/8" diameter PVC sheet

*Note: The Catch Tube shown here is partially filled with sand.

**Note: The inner diameter of PVC pipe varies with manufacture. Make sure the sample catch tube slides freely into the pipe before purchasing.

Figure 4. Cut-out of Cox Sand Catcher and construction specifications.



Figure 5. A Height Adjustment Tool is used to measure the height of Sensits and CSCs and to adjust the sensor and inlet height to 15 cm above the soil surface.

6.3. *PM Monitors*

6.3.1. TEOM – Previous studies have used PM₁₀ TEOMs.^{1,2,4} Other US EPA-approved continuous PM monitors, such as beta attenuation monitors can also be used.⁵ PM monitors may measure PM₁₀, PM_{2.5} or PM_{10-2.5}. At least two PM monitors are recommended; one that can serve as an upwind monitor to measure background concentrations and another for measurements downwind from the source area. In cases where downwind concentrations are very high relative to background concentrations and there are no other significant PM sources that contribute to the study area, the upwind background monitor does not necessarily have to be near the study area. Instead, an average regional background concentration representative of the study area under high wind conditions can be used in Equation 2. To determine an average regional background concentration, hourly PM monitor data from nearby sites should be screened to average PM concentrations when winds are high (hourly average above 5 m/s at 10-m height) and from wind directions that are not impacted by other dust sources that would not be representative of air upwind from the source area of interest. This information may be obtained from the state or local air pollution authority if they operate hourly PM monitors. PM monitors that are based on light-scattering measurement methods are not recommended for use with this test method due to variations in mass concentration readings caused by changes in particulate matter composition and particle size distribution.⁷

6.3.2. Data Logger – a data logger is needed to record hourly average PM concentrations if the PM monitor does not store hourly PM data.

6.3.3. Power Supply – US EPA-approved continuous PM monitors generally require line power or a large photovoltaic power system to provide sufficient power to operate. Propane powered generators can also be used for short-term sampling at remote locations.

6.4. *Meteorological Measurements*

6.4.1. Met Tower – A 10-m meteorological tower is recommended, but a lower height tower (e.g. 5 m) can also be used to reduce cost.

6.4.2. Wind Vane – a wind vane is needed to determine wind directions and sigma-theta for the study area and for the K-factor screening criteria.

6.4.3. Anemometer – wind speed is needed for the dispersion model and for the K-factor screening criteria.

6.4.4. Rain Gage – Precipitation data may help in the evaluation of changes in surface conditions that could affect wind erosion.

6.4.5. Data Logger - a data logger is needed to record hourly average wind speed, wind direction and other parameters. Note that 5-minute average wind speed and wind direction data, along with hourly gust information can be helpful in comparing sand flux measurements to wind speeds when checking for possible data errors and for evaluating threshold wind speeds.

6.4.6. Power Supply – solar panels with 20 amp-hr batteries are used to provide power for the data logger and other instruments.

6.4.7. Temperature, solar radiation, cloud cover – These are optional on-site measurement parameters used with the dispersion model to determine the meteorological stability class, since the stability class becomes neutral with moderate to high winds. These optional measurements may be substituted with data from a representative regional site. A pyranometer is used to measure solar radiation.

6.5. *Dispersion Modeling and Data Reduction Software*

6.5.1. Dispersion Model – The AERMOD and CALPUFF dispersion modeling systems (40 CFR, Part 51 Appendix W) have been used successfully with this test method for windblown dust.^{1,2,4} Both modeling systems have refined modeling routines to simulate near-field impacts from fugitive dust source areas.

6.5.2. Data Reduction – A spreadsheet or database software program is needed to store data for sand catch, Sensit readings, PM monitor concentrations, wind speed, wind direction, dispersion model outputs and other data collected as part of the study. The program is used to calculate and screen hourly K-factors and to calculate PM emissions.

7.0 Sample Collection, Preservation, Storage and Transport

7.1. *Preliminary Determinations - Prepare a Network Monitoring Plan.* The complexity of the network design for this test method can range from single sand flux, meteorological and PM monitor sites to estimate emissions from a small dust source area, to a network of over 100 sand flux sites, with multiple PM monitor and meteorological sites to measure dust from source areas in a 100 km² area. The number of monitoring sites should be tailored to the resources available for the project. More measurements will improve the accuracy of the results, but good emission estimates can still be derived from networks with fewer sand flux monitor sites. The accuracy of the emission estimate primarily relies on the downwind PM monitor. If there are 6 or more PM monitors being used for the project, a collocated PM monitor site should be established at the site of maximum impact. It is important to operate collocated monitors at this location to enhance the defensibility of the data being collected. Sand flux measurements provide inputs to the model based on the relative level of erosion activity in each area and what time it occurred. By collecting samples from multiple sand flux sites, a better representation of the area-wide average can be achieved. Ideally, the sand flux measurement from each site would be an average sand flux rate for the area it represents. However, because the dispersion model uses the downwind PM monitor to refine the PM emission estimates, any measurement bias in the sand flux measurement as compared to the actual average will be compensated for by adjustments in the K-factor to yield the correct PM emissions.

7.1.1. Sensit and CSC Monitor Locations - The sand flux monitoring area should include all significant windblown dust source areas between the upwind and downwind PM monitor site that could impact the downwind monitor. Significant dust source areas outside the monitoring area can be excluded in the K-factor analysis by screening the hourly data to only analyze hours when the wind direction is from the study area to the PM monitor site.

Sensits and CSCs should be collocated at sites 100 to 1,000 m apart. The density of the sand flux monitoring network is left to the user depending on available resources for the project. Sites can be placed in a grid pattern for random sampling or can be placed in locations to represent areas with different surface characteristics or different points of investigative interest.

Each Sensit/CSC pair must have a designated source area boundary that is represented by that site. The boundaries of those areas can be based on evenly spaced grids, on different surface conditions or topographical features, or on observed dust source area boundaries if such evidence is available for erosion events. Additional CSC units can also be placed in the field without collocated Sensits to provide better spatial information. Source area boundaries must be designated for each CSC site and hourly sand flux from CSC-only sites should be time-resolved using the nearest Sensit.

Collocated studies with the Cox Sand Catchers (CSC) have been conducted that demonstrate the precision of the instruments to be within $\pm 3\%$.¹ However, the precision of the CSCs and Sensits is difficult to determine in an area-source fugitive emissions study. It is more likely that variability in the measurements is attributable to variability in the source emissions impacting the monitors than in the monitoring devices themselves. Since precision is effectively determined by comparison of the modeled concentrations calculated from Sensit/CSC data with the monitored data collected at the PM monitoring stations, the need for collocated Sensit/CSC sand motion monitors is not necessary.

7.1.2. PM Monitor Locations - After reviewing pre-existing wind speed and direction data for the study area, the predominant wind directions should be determined for high wind events. PM monitors should be located upwind and downwind of the sand flux-monitored source area boundary. There should be no significant sources of dust other than the source area being monitored between the PM monitor and the dust source area boundary. The downwind monitor can be in or near the edge of the dust source area. If there is a lack of significant dust sources impacting the upwind side of the study area, and the downwind PM concentration is expected to be much higher than the upwind concentration, the upwind monitor concentration can be represented by a regional background concentration. This regional background can be estimated from the hourly average value during high wind events in areas not affected by windblown dust.

7.1.3. Meteorological Monitor Location - A 5 to 10-m meteorological tower should be installed in or near the study area. It must be equipped to measure and record hourly average scalar wind speed and direction and sigma-theta. As mentioned in the equipment description other optional meteorological parameters such as solar radiation, precipitation and temperature may be measured.

7.1.4. Sample Network - Figure 6 shows an example of a windblown dust monitoring network at Mono Lake, CA. It consists of 25 CSC sites, 2 Sensits, one meteorological tower and one PM₁₀ TEOM. The site is designed to monitor southerly windblown dust events. The boundaries of dust source areas are based on soil texture and topographical features caused by water eroded cut-banks on the playa. Sand flux for each of the CSC sites is time-resolved based

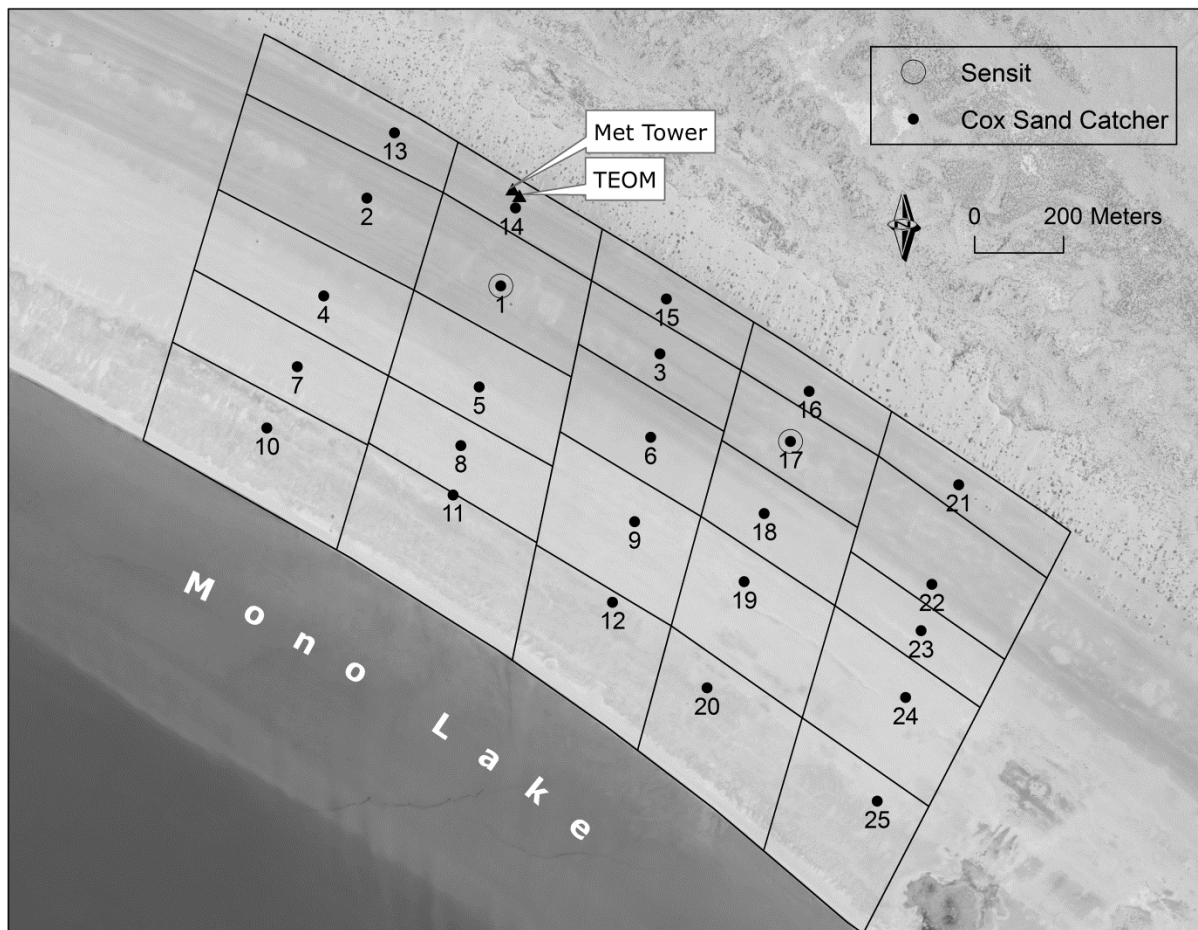

Figure 6. Example windblown dust monitoring network at Mono Lake, CA. The upwind PM₁₀ monitor is a regional background site located southwest of the lake. (July 2009 – June 2010)

on the particle count data from the nearest Sensit. The downwind PM monitor and meteorological tower are inside one of the downwind dust source areas. The upwind background PM concentration is based on the average PM₁₀ value during hours with high winds (>7.5 m/s at 10-m) from the south at a site located on the southwest side of Mono Lake.

7.2. Pre-test Preparation.

7.2.1. Meteorological Instruments – Calibrate anemometer, wind vane, and temperature gage in accordance with US EPA monitoring guidelines in EPA Volume IV.¹⁵ Check data logger connection and initiate data collection.

7.2.2 PM Monitor – Calibrate PM monitor in accordance with US EPA monitoring guidelines found in 40 CFR, Part 58, Appendix A, and in US EPA Volume II¹⁴. Check data logger connection and initiate data collection.

7.2.3 Cox Sand Catchers – Record empty tare weight of sand catcher sampling tubes on a laboratory documentation form.

7.3. Field Check for Sand Flux Measurement.

7.3.1. Cox Sand Catchers – Install empty sample tube and check and/or adjust inlet height to 15 cm using the Height Adjustment Tool and initiate sample collection. Verify that the

sample tube number corresponds to the site number on the field form. Record date and time of new tube installation and surface condition information on field documentation form. A sample field documentation form is shown in Figure 7. A blank field form is included in Appendix D.

7.3.2. *Sensit* – Check that the Sensit is responding by tapping on the sensor. Check data logger connection and power supply. Check and/or adjust sensor height to 15 cm above the surface using the Height Adjustment Tool. Initiate 5-minute sampling and data logger recording for the following parameters: Date and time, particle count (5-minute total), kinetic energy (5-minute total), and power supply voltage (reading every 5-minutes).

7.4. *Sample Recovery*. Sand captured in the CSCs is weighed both in the field and later in the laboratory to the nearest tenth of a gram. Field personnel should visit each site monthly or more often to avoid over-filling the CSC sample tubes. Site visits should only be conducted at times when wind erosion is not taking place. Site visits during an event can disturb the soil near the sand flux site, and can compromise Sensit data if a technician taps on the Sensit or interferes with data collection.

The following procedures are used when collecting the CSC samples and downloading Sensit data:

- 1) Park field vehicle 10 m or more away from the site and walk the remaining distance to the sampling site. Field personnel must access all Sensit and CSC sites from a direction that will minimize upwind surface impacts near the sampling sites.
- 2) Record surface conditions.
- 3) Measure and record the inlet height above the surface to the middle of the inlet.
- 4) Lift off the CSC inlet and remove the sample collection tube.
- 5) Verify collection tube number corresponds to site number on the field form.
- 6) Weigh and record the gross weight of the collection tube and sample to the nearest 1 gram using a field scale.
- 7) If any soil material is visible in the tube, seal the collection tube and place it in a secure place or in a tube rack for transport to the lab. If no soil material is visible, note this on the collection form and reuse the collection tube for the next sampling period.
- 8) Place a clean collection tube (if appropriate) in the CSC and record the collection tube number.
- 9) Replace the CSC inlet and adjust the height to 15 cm (± 1 cm).
- 10) Download Sensit data from the data logger to a data storage module.
- 11) Measure and record the Sensit sensor height above the surface to the center of the sensor using the Height Adjustment Tool, and adjust if necessary to 15 cm.
- 12) Perform a field operational response test on the Sensit by tapping on the sensor during each visit. Replace the Sensit if it does not show a response.
- 13) Return the CSC sample tubes to the laboratory for weighing on a bench-top lab scale.
- 14) Before weighing, visually determine if the CSC sample catch is wet or dry. Catches are considered dry if the sample appears loose and moves easily inside the catch tube when the tube is tilted on its side and shaken. Catches are considered wet if there is standing water in the sample catch tube or if darker layers in the catch tube appear moist and do not shift when the sample tube is tilted and shaken. Layers in a sample tube that are

COPY

Mono Lake
Sensit/CSC Field Form

Page 1/3

Technician: Chris Howard + Mike Slater Date (mm/dd/yyyy): 06/01/2010

Site #	Time (PST)	Pre-Sensit Height, cm	Sensit Response	Final Sensit Height, cm	Pre-CSC Inlet Height, cm	Field Cal Weight, kg	CSC Full, kg	CSC Tare, kg	Final CSC Height, cm
13	08:27	-	-	-	15	0.101	1.459	.243	15
2	08:39	-	-	-	16	0.101	1.429	.242	15
4	08:46	-	-	-	17.5	0.101	.735	.264	15
7	08:55	-	-	-	17.75	0.101	.507	.236	15
10	09:05	-	-	-	15	0.101	.335	.241	15
11	09:14	-	-	-	15	0.101	.370	.265	15
8	09:20	-	-	-	15	0.101	.776	.242	15
5	09:24	-	-	-	15.5	0.101	.807	.236	15
1	09:42	15	yes/yes	15	14	0.101	1.524	.383	15
14	09:58	-	-	-	15	0.101	1.325	.328	15
15	10:50	-	-	-	15	0.101	1.036	.334	15
16	10:58	-	-	-	15	0.101	1.724	.332	15

Photo

Marble Rankings: 0=No Crust 1=Complete Damage 2=Incident or Surface Damage 3=No Damage 4=Wet

Site #	Rank	Surface Description	Comments and Maintenance	
1	13	0	dry sandy gravel	
2	2	0	dry beach sand	
3	4	1	50% salt crusty, no growths, damp	CSC too high, swapped for shorter riser
4	7	2	wet salty crust 50% 50% sandy (wet)	CSC too high - swapped for shorter riser
5	10	2	100% salt crust - small cauliflower	old tare .250 - note taken
6	11	2	90% damp sand below	
7	8	0	20% salt crust, 80% moist sand	
8	5	0	damp sand w/ 20% salty crust	Re-dug CSC
9	1	0	dry sand	battery 14.068
10	14	0	dry pebbly sand	
11	15	0	dry pebbly sand	
12	16	0	dry pebbly sand	swapped bad (cracked) tube (3')
Delivered By:		Date:		
Received By:		Date:		

Figure 7. Sample field documentation form. A blank form is included in Appendix D of this OTM.

cemented and do not shift when the tube is tilted and shaken indicate that the sample was likely wet at some point. These are considered wet catches and must be dried before the sample is weighed.

- 15) Drying procedures for wet catches. Remove samples from the catch tube prior to drying. The sample catch tubes can melt if placed in the oven overnight. Use a brush to clean out the tube and make sure all the sample is removed from the tube. If possible use tweezers to remove any debris that may be in the sample, e.g. bugs and leaves. Sometimes rinsing the sample from the tube is necessary in order to get the sample out of the tube. Use distilled water and catch any water used to rinse the sample catch tube and dry it along with the rest of the sample. This will ensure that no catch was lost by rinsing. The sample may either be air-dried or placed in a drying oven until it has reached a constant weight when cooled. 24-hours in an oven at 105° C is usually adequate to dry wet samples. The oven temperature during the drying process must not exceed 110° C (230° F) in order to not drive off crystallographic water from the minerals present.
- 16) Weigh dry collection tubes and dried samples on a calibrated bench-top scale in the laboratory to the nearest 0.1 g.

7.5. *Chain of Custody.* Each field and laboratory form must be initialed and dated by the field and laboratory technician during each site visit and sample transfer to the laboratory.

7.6. *Maintenance Log.* Keep a log in the technicians field notebook of all repairs, maintenance, or replacement of Sensits or CSCs, and data logger equipment.

7.7. *Meteorological and PM Data.* Download PM monitor and meteorological data to a data storage module every site visit and at least once per month. A better alternative would be to collect the data via a telemetry system on a frequent, e.g., daily, basis.

8.0 Quality Control

8.1. Review Sensit and Sand Flux Data.

8.1.1. Review 5-minute Sensit data for missing records. Missing data may have been caused by low battery voltage or a data logger malfunction. Missing Sensit data from a site can be replaced by Sensit data from the next closest site to time-resolve CSC sand catch data.

8.1.2. Remove any Sensit data associated with tap response tests performed during site visits.

8.1.3. Check for anomalous data, such as non-zero Sensit readings during periods with low wind speeds that may be caused by something other than wind erosion. Note that sand flux may occur during hours with low hourly average wind speeds if there are significant wind gusts during that hour. This often happens at the beginning and end of a windy period when the hourly average wind speed may be low, but significant wind gusts occurred during that hour. If 5 minute wind speed and/or wind gust data was collected, this may also help reconcile non-zero sand flux that corresponded to periods with low hourly average wind speeds.

8.1.4. Check the Sensit reading to CSC sand mass ratio for each period to determine if the ratio is in the same range as previous sampling periods. Note that this ratio may vary based on the direction of the incoming sand flux due to non-uniformity in the Sensit sensor ring. It is helpful to maintain the Sensit sensor in the same compass direction to minimize changes in the calibration caused by the non-uniformity of the sensor ring. This measurement uncertainty is not

considered significant, but large differences, such as an order of magnitude or more, may be an indication that the Sensit should be replaced. Each Sensit has a unique response to sand flux, which causes the ratio of sand flux to the Sensit particle count (or kinetic energy) reading to be different for each Sensit. Although Sensits manufactured in the same batch usually have similar responses, all Sensits should be treated as instruments with individual sand flux calibration factors. Sensit instruments should be tracked individually to characterize the ratio of the sand flux to Sensit reading.

8.1.5. Missing sand catch mass data can occur if the CSC sample tube is left in the field too long and it over-fills, or if the sample is spilled. If it is collocated with a Sensit, ratios for the Sensit reading to the CSC sand catch for other sampling periods at that site can be used to estimate hourly sand flux from the hourly Sensit readings. A minimum estimate of the hourly sand flux should be calculated based on the sand catch mass for the full sample tube. If the Sensit calibration method doesn't yield a total sand catch for the sample period that is higher than the full sample tube mass, the minimum estimate from the full sample tube should be used instead of the Sensit calibration method. Any missing data that is replaced should be flagged in the database for future reference. If missing sand flux data is replaced with zero sand flux, the modeling analysis will associate zero emissions from this source area. If the emissions are significant as in the case of overfilled CSCs, this would affect K-factor calculations and emission estimates from each area represented by the sand flux sites.

8.2. *Review Meteorological Data.* Review wind speed, wind direction, sigma-theta and other meteorological measurements for missing records. Remove any data associated with audit/calibration checks. Check for possible anomalous data and investigate as needed.

8.3. *Review PM Data.* Review particulate matter data and check for missing data. Remove any data associated with audit/calibration checks. Check for possible anomalous data, such as high readings that may be associated with calibration checks or site visits and investigate as needed.

9.0 Calibration, Standardization, and Quality Assurance

9.1. *Quality Assurance Audits.* Calibration and standardization tasks may be conducted by staff operating the monitoring network on a routine basis. Quality assurance audits must be conducted by a qualified third-party not involved with the routine operation of the project utilizing standards that are separate from those used for routine calibration checks.

9.2. *Mass Measurements.* Check all lab balances before and after every weighing session using National Institute of Standards and Technology (NIST) Class F weights. Check field scales with NIST Class F certified weights before and after every field day, and during the day with a 100-gram weight at each sample site before weighing the sand catch and recording the weight on the field form. Check the bench-top balance in the laboratory with NIST Class F weights before sand catches are weighed. Record test weights on the balance log sheet in the laboratory. Calibrate and certify all balances at least once every year using a qualified third-party that can certify, adjust, and repair the balances.

9.3. *Meteorological Monitoring Station(s).* Verify the operation of all meteorological sensors using the procedures specified in US EPA QA Handbook Volume IV.¹⁵ All sensors must be audited within 30 days of installation and every six months thereafter.

9.4. *Particulate Matter Monitoring Stations.* Monitors for particulate matter (PM) must be US EPA-certified equivalent method continuous monitors capable of providing hourly-resolved PM concentrations. The monitors must be operated and maintained, at a minimum, according to

US EPA guidelines for ambient monitoring provided in 40 CFR, Part 58, Appendix A and those found in the US EPA QA Handbook Volume II.¹⁴ Equipment operators should be prepared to increase the frequency of routine maintenance activities based on the conditions under which the monitors are operated. It is not unusual for downwind monitors located near a dust source to measure hourly concentrations in the thousands or even tens-of-thousands of micrograms per cubic meter. In this case, maintenance activities such as inlet cleaning and filter change frequency must be increased, e.g. weekly PM inlet cleanings and filter changes after every storm event in order to ensure the collection of high quality defensible data.

9.5. *Dispersion Modeling.* The modeling effort shall be conducted following US EPA guidelines for dispersion modeling as provided in Title 40 CFR, Part 51, Appendix W.¹⁷

10.0 Data Analysis and Calculations

10.1. *Calculate Hourly Sand Flux.* Time-resolve mass measurements from CSCs with Sensit readings to calculate hourly sand flux at each site using Equation 3 as follows:

$$\text{---} \text{---} \text{---} \tag{3}$$

where,

- = sand flux (at 15 cm height) for hour i at CSC site c [$\text{g}/\text{cm}^2\text{-hr}$]
- = sand catch mass for period p at CSC site c [g]
- = Sensit particle count (or kinetic energy) for hour i , with n number of hours during period p at Sensit site s (closest Sensit to CSC site c) [counts]
- 1.2 = inlet area size of CSC based on BSNE comparison [cm^2]

10.2. *Review Hourly Sand Flux.* Perform quality control checks for missing data and anomalous sand flux estimates as discussed in Section 8.1.

10.3. *Dispersion Modeling.* Run the AERMOD or CALPUFF dispersion modeling system following US EPA modeling guidance (40 CFR, Part 51, Appendix W). The source area configuration for each dust source area is applied using boundaries of the source areas represented by each CSC configured to account for surface features and different soil textures as discussed in Section 7.1.1. PM_{10} emissions from each dust source are first estimated by applying the hourly sand flux in Equation 3 to estimate PM_{10} emissions in Equation 1 with an initial K-factor, $K_i = 5 \times 10^{-5}$. Prepare a meteorological data input file for the dispersion model of choice using scalar wind speed, scalar wind direction, and sigma-theta measurements. Regional upper air and cloud cover observations and/or local measurements of solar radiation and differential temperature would typically be necessary depending on the dispersion model selected for the analysis. Receptor locations for model predictions must include the downwind PM monitor site. Select dispersion model options according to the US EPA regulatory guidance associated with each model. Options specific to area source simulation and mass depletion should be selected on a case-by-case basis depending on the source to receptor relationship. A precise area source algorithm is suggested when the PM monitor is close to the emitting dust source. Dry deposition and subsequent depletion of mass from the dust plumes depend on the particle size distribution. The dry deposition option can be turned off if the user does not have size distribution data. For the very windy conditions on November 20, 2009 at Mono Lake, the downwind concentrations for 1, 3 and 10 micron particles would have been 99%, 80% and 76%, respectively of the

concentrations without plume depletion. Particle size distribution data relevant for the source area should be collected if the dry deposition option is turned on in the model.

10.4. *Compile Monitoring Data and Initial Model Results.* Compile hourly data and initial model results in a database or spreadsheet data management system. Data shall include: date, hour, wind speed, wind direction, upwind PM concentration, downwind PM concentration, sand flux, and the initial dispersion model prediction of PM concentration for the downwind PM monitor location. Note that the upwind PM concentration is treated as the background concentration for K-factor calculations. This may be replaced by a representative regional background concentration for high wind conditions if an upwind monitor is not located adjacent to the study area. See Section 6.3.1. regarding calculating a regional background concentration.

10.5. *Calculate K-factors.*

Step 1: Calculate hourly K-factors in the data management system using Equation 2. Hourly PM concentrations upwind from the study area should be used in Equation 2 for background concentrations. However, an average background PM concentration for high wind conditions at nearby site(s) upwind from windblown dust areas can be used in Equation 2, if it can be considered representative of concentrations upwind from the study area.

Step 2: Screen the hourly K-factors to remove hours that did not have strong source-receptor relationships between the monitored dust source areas and the downwind PM monitor. Documentation of all screened hourly K-factors must be retained such as in a spreadsheet form. Thresholds for the screening criteria shall be tailored to the project to ensure that a reasonable number of hours pass the screens. This could include lowering PM₁₀ screens to 50 $\mu\text{g}/\text{m}^3$ and/or sand flux to 0.1 $\text{g}/\text{cm}^2\text{-hr}$. The following suggestions for screening criteria are based on those applied in previous successful studies:^{1,2,4}

1. Wind speed is greater than 5 m/s (11 miles per hour) at 10-m anemometer height.
2. Hourly modeled and monitored PM₁₀ concentrations were both greater than 150 $\mu\text{g}/\text{m}^3$.
3. Hourly wind direction was within 15 degrees of the direction of the sand flux site to the downwind monitor.
4. Hourly sand flux is greater than 0.5 $\text{g}/\text{cm}^2\text{-hr}$.

Step 3: Seasonal K-factors can be generated from screened hourly K-factors by looking for shifts in K-factor values. The use of seasonal K-factors provides a longer-term stable value that helps to compensate for uncertainty in hourly K-factors associated with sand flux estimates, dispersion model assumptions, and PM₁₀ monitor measurements. It is recommend that seasonal K-factors be based on the geometric mean value of K-factors during each period, and that there be 9 or more hourly values in a seasonal period. This value will provide good seasonal estimates of median PM emissions. For regulatory purposes, the 75-percentile seasonal K-factor has been used to estimate the potential PM emissions for dust control purposes.⁴

Spatial K-factors may be appropriate for different dust source areas within the modeling domain. Differences in soil texture (e.g. sand versus clay soils) or surface conditions can be related to different K-factor ranges. If the monitoring network is set up to monitor multiple surface variations, K-factors can be calculated for each area. Setting up the monitoring network to isolate K-factors from different areas requires good planning to identify downwind monitor locations for each source area. Both spatial and temporal K-factors have been successfully calculated in previous studies at Owens Lake, CA.^{1,4}

10.6. *Calculate PM Emissions.* Calculate hourly PM emissions from each source area by applying seasonal K-factors to Equation 1 shown by Equation 4 as follows:

(4)

where,

- = vertical PM flux for hour i at CSC site c [$\text{g}/\text{cm}^2\text{-hr}$]
- = geometric mean K-factor for seasonal period t [dimensionless]
- = sand flux (at 15 cm height) for hour i at CSC site c [$\text{g}/\text{cm}^2\text{-hr}$]

The PM emission flux estimate from Equation 4 is then multiplied by the surface area size of source area c [cm^2] to estimate the total PM emissions for each hour.

11.0 Other Useful Results

11.1. *Method Performance.* Due to the lack of a better measurement method for estimating PM emissions from windblown dust, there is no way to ascertain the true precision and bias of PM emission measurements using this method. However, a comparison of model predictions and observed PM monitor concentrations can provide a relative sense of how well predicted emissions correspond with changes in monitored concentrations, and how much confidence can be given to model predictions at other receptor locations. To determine the model impacts with the seasonal K-factors applied to Equation 4, it is not necessary to re-run the dispersion model. Model results can be re-calculated using the relationship in Equation 2 to relate the initial and seasonal K-factor to the initial and revised model results shown by Equation 5 as follows:

— (5)

where,

- = Revised hourly PM concentration for hour j [$\mu\text{g}/\text{m}^3$]
- = Initial model-predicted PM concentration for hour j [$\mu\text{g}/\text{m}^3$]
- = geometric mean K-factor for seasonal period t [dimensionless]
- = initial K-factor (5×10^{-5}) [dimensionless]
- = Background PM monitor concentration for hour j [$\mu\text{g}/\text{m}^3$]

The revised hourly PM concentrations from Equation 5 can be compared to the hourly monitored concentrations for the same periods. These results can then be compared statistically to evaluate model performance. To avoid misleading model performance results, hourly monitor and model pairs for statistical analyses should be screened to only compare the hours when the monitor is downwind from the dust source areas.

11.2. *Hourly, Daily and Annual PM Emissions.* Daily and annual PM emissions can be summarized from the hourly estimates using Equation 4. When windblown dust is the dominant source of PM at the downwind monitor site, hourly and daily PM emissions and concentrations should be highly correlated.

12.0 Sample Application

The method used in this document was used to quantify windblown dust emissions at Mono Lake, California.² A network of 25 CSCs and two Sensits were used to measure sand flux in a 2 km^2 study area. A TEOM measured hourly PM_{10} concentrations on the downwind side of the sand flux network. A satellite photo of the study area and the monitoring network is shown in Figure 6. Boundaries for the source areas were based on soil texture in each area and topographical features on the playa.

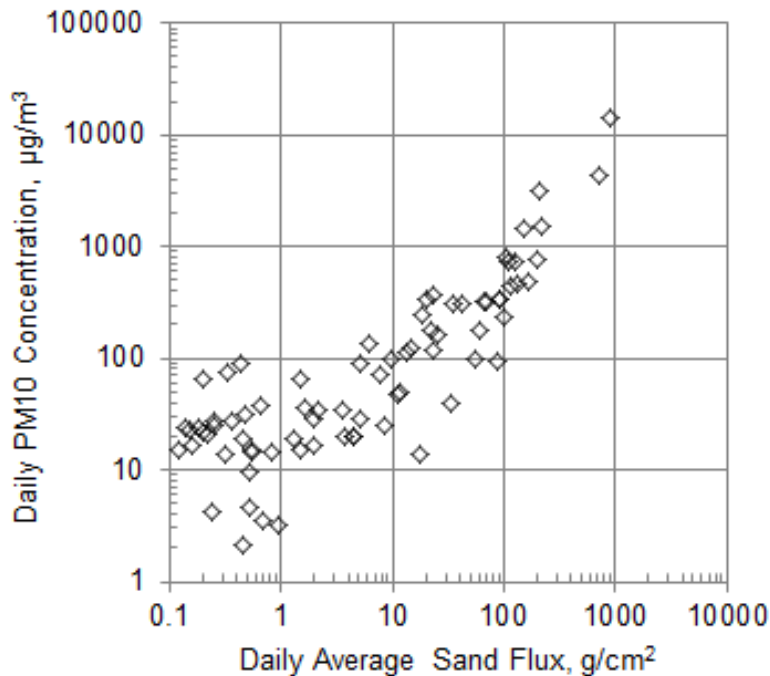

Figure 8. Daily average sand flux from the study area at Mono Lake was linearly related to PM₁₀ concentrations at the downwind monitor site (July 2009-June 2010).

The relationship of daily sand flux in the study area to PM₁₀ concentrations at the nearby monitor site were linearly related as shown by the log-log plot in Figure 8 (slope=11.1, $R^2=0.82$). Data were collected from July 2009 through June 2010. The linear relationship between sand flux and PM₁₀ supports the theory that PM emissions are proportional to sand flux. In terms of potential PM₁₀ impacts, average daily sand flux of around 25 g/cm²-day measured at 15 cm above the surface corresponded to daily PM₁₀ concentrations of around 150 µg/m³.

Hourly K-factors were calculated using Equation 2 and screened using the criteria described in Section 10.5 to ensure a strong source-receptor relationship. Hourly K-factors are plotted versus time in Figure 9. Several seasonal K-factor cut-points were selected based on shifts observed in K-factor values. The geometric mean K-factor values ranged from 1.3×10^{-5} to 5.1×10^{-5} . Note that the lack of K-factors from December through March was associated with a period when sand flux was zero because the surface was in a non-erodible condition as a result of either snow cover or moist soil.

Seasonal K-factors were applied to the hourly sand flux to calculate hourly PM₁₀ emissions using Equation 4. Hourly PM₁₀ emissions are plotted as a function of wind speed as shown on the log-log plot in Figure 10. The Mono Lake wind tunnel PM₁₀ emissions algorithm that was originally used to model PM₁₀ at Mono Lake is plotted on the same graph to show the contrast between assuming windblown dust emissions as a simple function of wind speed and the scatter in actual emissions versus wind speed.⁸ The Mono Lake portable wind tunnel PM₁₀ emissions algorithm that was originally used to model PM₁₀ at Mono Lake underestimated monitored impacts for large events at this site by about a factor of 7.⁹ The use of the sand flux-based hourly emission rates significantly improved model predictions. It should be noted that wind tunnel emission algorithms are normally derived from a limited number of tests. In this

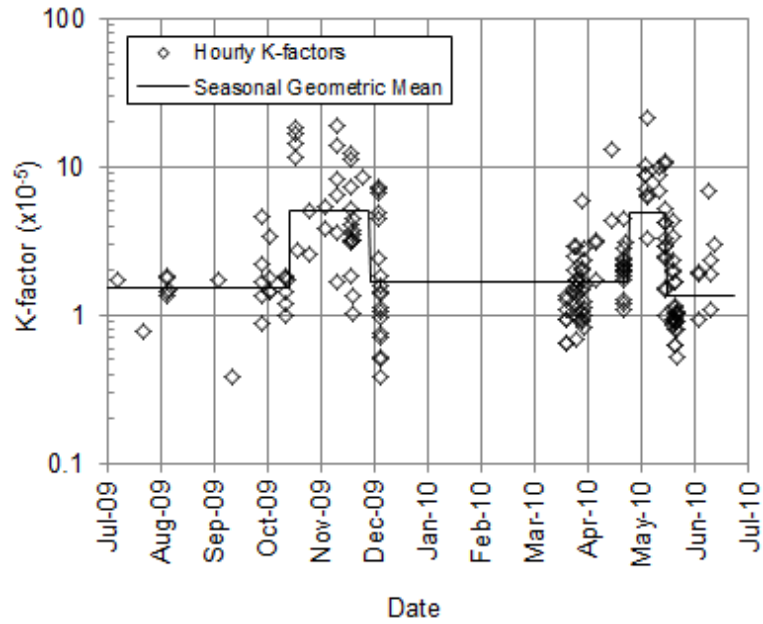

Figure 9. Seasonal shifts in the hourly K-factors at Mono Lake, CA were believed to be caused by changes in surface conditions that affected wind erosion.

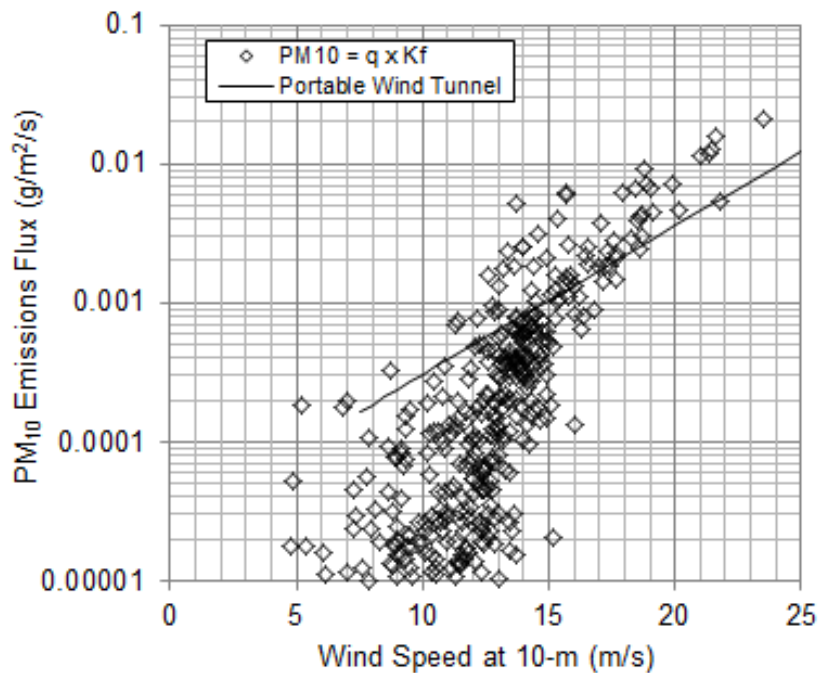

Figure 10. Hourly PM₁₀ emission rates using the windblown dust test method were often quite different from those predicted from wind tunnel tests at Mono Lake, CA.

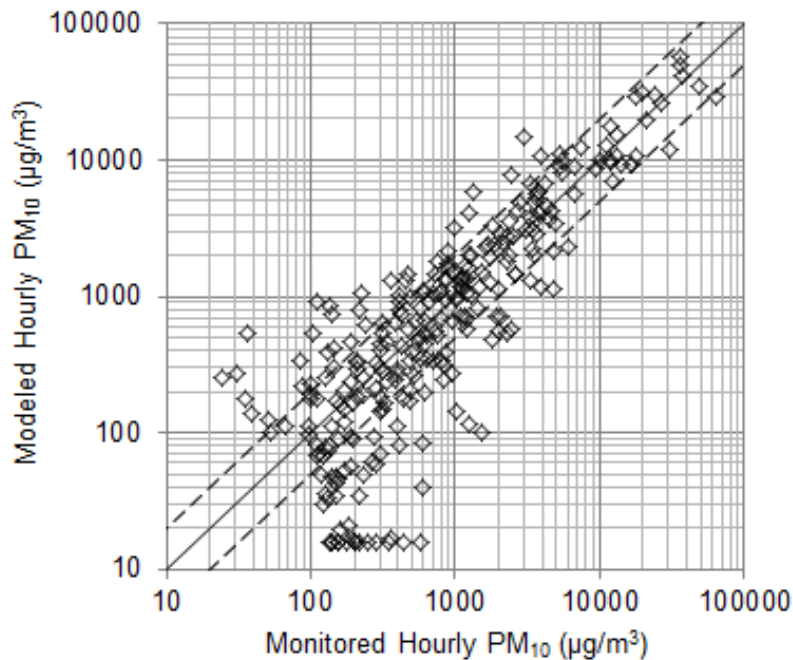

Figure 11. Modeled PM_{10} compared to monitored PM_{10} at Mono Lake. The dashed lines are a factor of two above and below the one to one line.

case, there were only 6 data points to derive the wind tunnel algorithm,¹⁰ as compared to the 355 hourly data points for the windblown dust test method shown in Figure 10. This semi-log plot does not show hours with zero emissions for which there were 8,020 hours during the one-year study period.

A comparison of hourly model concentrations to downwind PM_{10} monitor concentrations is shown by the log-log plot in Figure 11. Sixty percent of the hourly model concentrations were within a factor of 2 above or below the PM_{10} monitor concentrations as indicated by the dashed lines. Statistically, the model prediction versus monitor concentration comparison had a slope of 0.89 and the R^2 was 0.77. Figure 12 shows that the model-predicted PM_{10} concentrations tracked favorably with the monitor concentrations over a 4-order of magnitude range for the largest dust event during the study period on November 20, 2009. The 24-hour average concentration for this event was $14,147 \mu\text{g}/\text{m}^3$ and the model-predicted concentration was $16,062 \mu\text{g}/\text{m}^3$. The maximum hourly PM_{10} emission rate for this event was $76 \text{ g}/\text{m}^2\text{-hr}$, which occurred with an hourly average wind speed of 23.5 m/s (53 miles per hour). Maximum daily PM_{10} emissions were $450 \text{ g}/\text{m}^2\text{-day}$ on November 20, 2009. For the one year study period the annual emission rate was estimated to be $1,095 \text{ g}/\text{m}^2\text{-yr}$.

13.0 BSNEs and Other Sand Flux Instruments

The methodology described in this document recommends the use of CSCs to measure sand flux. Other types of sand flux measurement instruments have been used by wind erosion researchers. One common type that has been used by the US Department of Agriculture and others for wind erosion studies is the BSNE manufactured by Custom Products in Big Springs, TX. BSNEs have wind vanes to point the inlets into the wind. They are often placed at multiple heights above the surface to measure total sand flux, which is the mass of sand-sized particles

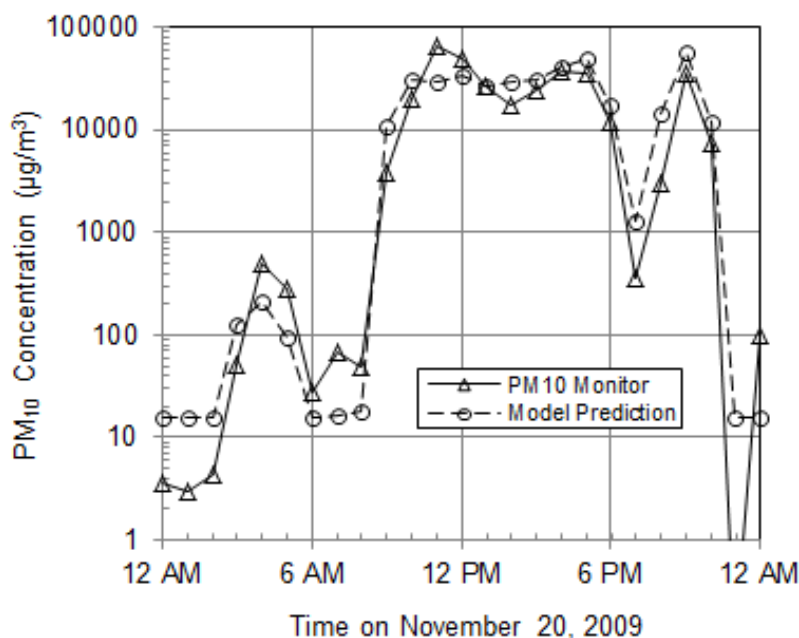

Figure 12. PM₁₀ model predictions using the windblown dust test method tracked favorably with monitor concentrations over a 4-order magnitude range as shown for this dust event on November 20, 2009 at Mono Lake, CA.

passing perpendicular through a vertical plane of given width and infinite height [mass/length]. Total sand flux can be calculated by measuring sand flux at multiple heights, fitting the data to a mathematical curve^{1,11} and then integrating from 0 to 1 m, which is the region where most of the saltation flux occurs. For relatively flat terrain, the flux at a given height is proportional to the total sand flux. The proportion of sand flux at 15 cm can be determined by integrating the sand flux from 14.5 to 15.5 cm and comparing it to the total sand flux. Long-term measurements using multi-height BSNE samplers at Owens Lake¹ found that the relationship of the total sand flux, Q to the sand flux at 15 cm (q_{15}) was

$$\text{---} \quad (6)$$

This same relationship was confirmed by another study in a coastal dune area in California.¹² It should be noted that the BSNE has a smaller storage volume than CSCs and that daily site visits may be needed to avoid overloading the BSNE samplers in areas with high erosion activity.

14.0 Using Sand Flux Measurements as a Survey Tool

14.1. *Survey Tool and Control Measure Evaluation.* Sand flux measurements can provide useful information by themselves, even if PM₁₀ monitor data or modeling information is not available. Sampling with CSCs can identify areas that are susceptible to wind erosion. With multiple sample sites collecting data, a relative gage of wind erosion in each area can be

ascertained. This type of information can be useful when evaluating the effectiveness of dust control measures.

14.2. *Estimating PM Emissions with Sand Flux.* If K-factors are available for a soil type, sand flux data can be used to estimate PM dust emissions for a given sampling period. For loose sandy soils, such as those found in sand dunes a K-factor range of 1.3×10^{-5} to 5.1×10^{-5} was measured from the exposed playa at Mono Lake, California in the example provided in Section 12.0. A similar range of K-factors has been measured for sandy playa soils and sand dunes at Owens Lake, California.^{1,2,4} These sites are more than 100 miles apart and in different hydrologic basins, but have similar K-factor ranges. As more soil types are tested using this method other K-factor ranges may be determined. However, it should be noted that better PM emission quantification requires upwind and downwind monitoring of PM to determine K-factors specific for the source area of interest. Once a K-factor range is determined for the soil type and conditions of interest, default K-factors based on that range could be used with sand flux data to estimate PM emissions.

14.3. *Wind Erosion Threshold.* Combining Sensits with CSCs allows the user to time-resolve sand flux. Hourly sand flux and wind speed data can be analyzed to determine the threshold wind speed, which is the wind speed that initiates wind erosion.^{12,13} If collected, 5 minute wind speed data can be used with the 5-minute sand flux data to give a more refined threshold determination. Threshold wind speed information is helpful for control measure evaluation and for identifying situations where exceptionally high wind speeds may cause dust control measures to lose their effectiveness.

REFERENCES

1. Gillette, D.; Ono, D.; Richmond, K. A combined modeling and measurement technique for estimating windblown dust emissions at Owens (dry) Lake, California, *J. Geophys. Res.* **2004**, 109, F01003; doi:10.1029/2003JF000025.
2. Ono, D., Richmond, K., Kiddoo, P., Howard, C., Davis, G. Application of a combined measurement and modeling method to quantify windblown dust emissions from the exposed playa at Mono Lake, California. *J. Air & Waste Management Assoc.*, **2011**, doi10.1080/10473289.2011.596760.
3. Shao, Y.; Raupach, M.R.; Findlater, P.A. Effect of saltation bombardment on the entrainment of dust by wind. *J. Geophys. Res.* **1993**, 98, 12719-12726.
4. Great Basin Unified Air Pollution Control District, *2008 Owens Valley PM₁₀ Planning Area Demonstration of Attainment State Implementation Plan*, Bishop, CA, 2008.
5. US Environmental Protection Agency, *List of Designated Reference and Equivalent Methods*, Research Triangle Park, NC, <http://www.epa.gov/ttnamti1/criteria.html> (accessed June 2011).
6. Sensit Company, website for Sensit instruments, <http://sensit.org/default.aspx>, (accessed June 2011).
7. Lanane, C., Johnson, D. *A Comparison of PM₁₀ Survey Monitors*, Great Basin Unified Air Pollution Control District, presented at the Air & Waste Management Association Symposium on Air Quality Measurement Methods and Technology, Los Angeles, CA, November 2-4, 2010.
8. Great Basin Unified Air Pollution Control District, *Mono Basin Planning Area PM-10 State Implementation Plan*, Bishop, CA, 1995, 46-47.

9. Great Basin Unified Air Pollution Control District, *Reasonable Further Progress Report for the Mono Basin PM-10 State Implementation Plan*, GBUAPCD, Bishop, CA, September 2010.
10. Ono, D. *Mono Lake Modeling Emission Algorithm*; memo to Ken Richmond: Great Basin Unified Air Pollution Control District, Bishop, CA, March 23, 1993.
11. Shao, Y., Raupach, M.R. The overshoot and equilibrium of saltation, *J. Geophys. Res.*, **97**, **1992**, 20,559-20,564.
12. Craig, J., Cahill, T., Ono, D. *South County Phase 2 Particulate Study*; Appendix B: San Luis Obispo County Air Pollution Control District; San Luis Obispo, CA, February 2010.
13. Ono, D. Application of the Gillette model for windblown dust at Owens Lake, CA, *Atmospheric Environment*, **40**, **2006**, doi:10.1016/j.atmosenv.2005.08.048, 3011-3021.
14. US Environmental Protection Agency, Quality Assurance Handbook for Air Pollution Measurement Systems, Volume II: Ambient Air Quality Monitoring Program, EPA-454/B-08-003, December 2008.
15. US Environmental Protection Agency, Quality Assurance Handbook for Air Pollution Measurement Systems, Volume IV: Meteorological Measurements, Version 2.0 (Final), EPA-454/B-08-002, March 2008.
16. Code of Federal Regulations Title 40: Protection of the Environment, Part 58: Ambient Air Quality Surveillance, Appendix A: Quality Assurance Requirements for SLAMS, SPMs, and PSD Air Monitoring.
17. Code of Federal Regulations Title 40: Protection of the Environment, Part 51: Requirements for Preparation, Adoption, and Submittal of Implementation Plans, Appendix W: Guideline on Air Quality Models.
18. US Environmental Protection Agency, Quality Assurance Guidance Document 2.12 Monitoring PM_{2.5} in Ambient Air Using Designated Reference or Class I Equivalent Methods, <http://www.epa.gov/ttnamti1/files/ambient/pm25/qa/m212covd.pdf> (accessed February 2012), November 1998.

Appendix A
List of Required Measurements to Quantify
PM Emissions from Windblown Dust

Measurement Parameter	Equipment	Required at test site?
Hourly Average Particulate Matter	TEOM, BAM or other Federal Equivalent Method PM monitors capable of measuring hourly PM ₁₀ or PM _{2.5} concentrations at upwind and downwind locations. The upwind PM monitor may be located at a local site representative of conditions upwind from the test area during wind event periods.	Yes
Hourly Average Scalar Wind Speed	Anemometer positioned at 5 to 10 meters above the surface.	Yes
Hourly Average Scalar Wind Direction	Wind vane positioned at 5 to 10 meters above the surface.	Yes
Sigma Theta ($\sigma\theta$)	Standard deviation of azimuth angle of wind direction.	Yes
Precipitation	Rain gauge (optional measurement)	No
Ambient Temperature	Thermistor (local data may be used)	No
Barometric Pressure	Aneroid Barometer (local data may be used)	No
Relative Humidity	Psychrometer/hygrometer (local data may be used)	No
Solar Radiation	Pyranometer (local data may be used)	No
Cloud Cover	Visual observation (local data may be used)	No
Hourly Average Sand Flux	Cox Sand Catchers or BSNEs with Sensits at one or more sites to time-resolve sand catch mass to estimate hourly sand flux at each location. A lab balance capable of measuring to ± 0.1 g will be needed to determine sand catch mass.	Yes

Data loggers will be needed to record meteorological and Sensit data. Additional data loggers may be used to back-up the internal data storage devices on the PM monitors. Power supplies for the meteorological tower and Sensit can be provided by solar power systems. PM monitors will likely need line power to provide sufficient power to operate continuously.

BLANK PAGE

Appendix B Measurement Quality Objectives Validation Template

Measurement Quality Objectives (MQOs) for all PM_{2.5} and PM₁₀ monitoring conducted for this method should follow the guidance provided by the USEPA for measuring ambient PM concentrations using Federal Equivalent Method monitors. As discussed in the method description and listed in Appendix A, some meteorological measurements are not required, but MQOs are included in this appendix to provide complete information for the user.

Continuous PM_{2.5} Local Conditions Validation Template¹⁴

Criteria	Frequency	Acceptable	Information (CFR or QA Guidance 2.12 ¹⁸)
Sampling Period			
24 hour estimate	every sample period	1380-1500 minutes, or value if < 1380 and exceedance of NAAQS ¹⁷ midnight to midnight	40 CFR Part 50 App. L, Sec 3.3 40 CFR Part 50, App. L, Sec 7.4.15
Hour estimate	Every hour	Instrument dependent	See operators manual
Sampling Instrument			
Average Flow Rate	every 24 hours of op	average within 5% of 16.67 liters/minute	40 CFR Part 50 App. L, Sec 7.4
Variability in Flow Rate	every 24 hours of op	CV ≤ 2%	40 CFR Part 50, App. L, Sec 7.4.3.2
Verification/Calibration			
One-point Flow Rate Verification	1/4 weeks	± 4% of transfer standard	40 CFR Part 50, App. L, Sec 9.2.5 40 CFR Part 58, App. A, Sec 3.2.3 & 3.3.2
Reference Membrane Verification (BAM)	Hourly	± 4% of ABS Value	
Verification/Calibration			
Leak Check	every 30 days	Instrument dependent	40 CFR Part 50, App. L, Sec 7.4
Temperature Calibration	if multi-point failure	± 2 °C	40 CFR Part 50, App. L, Sec 9.3
Temp M-point Verification	on installation, then 1/yr	± 2 °C	40 CFR Part 50, App. L, Sec 9.3
One-point Temp Check	1/4 weeks	± 2 °C	40 CFR Part 50, App. L, Sec 9.3
Pressure Calibration	on installation, then 1/yr	± 10 mm Hg	40 CFR Part 50, App. L, Sec 9.3
Pressure Verification	1/4 weeks	± 10 mm Hg	40 CFR Part 50, App. L, Sec 9.3
Other Monitor Calibrations	per manufacturers' op manual	per manufacturers' operating manual	
Flow Rate (FR) Calibration	if multi-point verification	± 2%	40 CFR Part 50, App. L, Sec 9.2
FR Multi-point Verification	1/yr	± 2%	40 CFR Part 50, App. L, Sec 9.2
Design Flow Rate Adjustment	at one-point or multi-point	± 2% of design flow rate	40 CFR Part 50, App. L, Sec 9.2.6
Precision			
Collected Samples	every 12 days for 15% of sites	CV < 10% of samples > 2 µg/m ³	40 CFR Part 58, App. A, Sec 3.2.5

Criteria	Frequency	Acceptable Range	Information (CFR or QA Guidance 2.12 ¹⁸)
Accuracy			
Temperature Audit	2/yr	± 2 °C	QA Guidance Document 2.12, Sec 10.2
Pressure Audit	2/yr	±10 mm Hg	QA Guidance Document 2.12, Sec 10.2
Semi Annual Flow Rate Audit	2/yr	± 4% of audit standard ± 5% of design flow rate	QA Guidance Document 2.12, Sec 10.2
Calibration & Check Standards (working standards)			
Field Thermometer	1/yr	± 0.1 °C resolution, ± 0.5 °C accuracy	QA Guidance Document 2.12, Sec 4.2 & 6.4
Field Barometer	1/yr	± 1 mm Hg resolution, ± 5 mm Hg accuracy	QA Guidance Document 2.12, Sec 4.2 & 6.5
Shelter Temperature			
Temperature range	Daily (hourly values)	20 to 30 °C (hourly average), or per manufacturers' specifications if designated to a wider temperature range	Generally the 20-30 °C range will apply but the most restrictive operable range of the instruments in the shelter may also be used as guidance
Temperature Control	Daily (hourly values)	± 2 °C SD over 24 hours	
Temperature Device Check	2/year	± 2 °C	
Monitor Maintenance			
Virtual Impactor Very Sharp Cut Cyclone	Every 30 days	cleaned/changed	QA Guidance Document 2.12, Sec 9.2
Inlet Cleaning	Every 30 days	cleaned	QA Guidance Document 2.12, Sec 9.3
Filter Chamber Cleaning	1/4 weeks	cleaned	QA Guidance Document 2.12, Sec 9.3
Circulating Fan Filter Cleaning	1/4 weeks	cleaned/changed	QA Guidance Document 2.12, Sec 9.3
Manufacturer-Recommended Maintenance	per manufacturers' SOP	per manufacturers' SOP	
SYSTEMATIC CRITERIA- PM_{2.5} Continuous, Local Conditions			
Data Completeness	monthly	≥ 90%	Part 50, App. N, Sec. 4.1 (b) 4.2 (a)
Reporting Units		µg/m ³ at ambient temp/pressure (PM _{2.5})	40 CFR Part 50.3
Rounding Convention			
Annual 3-yr average	quarterly	nearest 0.1 µg/m ³ (≥0.05 round up)	40 CFR, Part 50, App. N, Sec 2.3
24-hour, 3-year average	quarterly	nearest 1 µg/m ³ (≥0.5 round up)	40 CFR Part 50, App. N, Sec 2.3
Detection Limit			
Lower DL	all filters	≤ 2 µg/m ³	40 CFR Part 50, App. L, Sec 3.1
Upper Conc. Limit	all filters	≥ 200 µg/m ³	40 CFR Part 50, App. L, Sec 3.2

Criteria	Frequency	Acceptable Range	Information (CFR or QA Guidance 2.12 ¹⁸)
VERIFICATION/CALIBRATION STANDARDS RECERTIFICATION - All standards should have multi-point certifications against NIST Traceable standards			
Flow Rate Transfer Std.	1/yr	± 2% of NIST-traceable Std.	40 CFR Part 50, App. L, Sec 9.1 & 9.2
Field Thermometer	1/yr	± 0.1 °C resolution, ± 0.5 °C accuracy	QA Guidance Document 2.12, Sec 4.2.2
Field Barometer	1/yr	± 1 mm Hg resolution, ± 5 mm Hg accuracy	QA Guidance Document 2.12, Sec 4.2.2
Calibration & Check Standards			
Flow Rate Transfer Std.	1/yr	± 2% of NIST-traceable Std.	40 CFR Part 50, App. L, Sec 9.1 & 9.2
Verification/Calibration			
Clock/timer Verification	1/4 weeks	1 min/mo**	40 CFR Part 50, App. L, Sec 7.4
Precision			
Single analyzer	1/3 mo.	Coefficient of variation (CV) ≤ 10%	
Single analyzer	1/yr	CV ≤ 10%	
Primary Quality Assurance Org.	Annual and 3 year estimates	90% CL of CV ≤ 10%	40 CFR Part 58, App. A, Sec 4.3.1
Bias			
Performance Evaluation Program (PEP)	8 audits for > 5 sites	±10%	40 CFR Part 58, App. A Sec 3.2.7, 4.3.2

1/ = value must be flagged due to current implementation of BAM (sampling 42 minute/hour) only 1008 minutes of sampling in 24 hour period

*** = not defined in CFR**

SD = standard deviation

CV = coefficient of variation

@ = scheduled to occur immediately after impactor cleaned/changed

**** = need to ensure data system stamps appropriate time period with reported sample value**

Continuous PM₁₀ Standard Temperature and Pressure Conditions Validation Template¹⁴

NOTE: There are a number of continuous PM₁₀ monitors that are designated as Federal Equivalent Monitors. These monitors may have different measurement or sampling attributes that are not identified in this validation template. Monitoring organizations should review specific instrument operating manuals to augment this validation template as necessary. In general, 40 CFR Part 58 App. A and 40 CFR part 50 App. J requirements apply to Continuous PM₁₀. Since a guidance document was never developed for continuous PM₁₀, many of the requirements reflect a combination of manual and continuous PM_{2.5} requirements and are therefore considered recommendations.

Criteria	Frequency	Acceptable Range	Information (CFR or QA Guidance 2.12 ¹⁸)
CRITICAL CRITERIA- PM₁₀ Continuous			
Sampling Period	all filters	1380-1500 minutes, or value if < 1380 and exceedance of NAAQS ^{1/} midnight to midnight	40 CFR Part 50 App. J, Sec 7.1.5
Sampling Instrument			
Average Flow Rate	every 24 hours of operation	Average within ± 10% of design	recommendation
Verification/Calibration			
One-point Flow Rate Verification	1/mo	± 5% of transfer standard and 10% from design	40 CFR Part 58, App. A, Sec 3.2.3
OPERATIONAL EVALUATIONS TABLE PM₁₀ Continuous			
Verification/Calibration			
System Leak Check	During pre-calibration check	Instrument dependent	QA Guidance Document 2.12, Sec 6.62
FR Multi-point Verification/Calibration	1/yr	3 of 4 cal points within ± 10% of design	QA Guidance Document 2.12, Sec 6.3.4
Audits			
Quarterly Flow Rate Audit	1/3 mo	± 5% of audit standard and ±10% of design value	40 CFR Part 58, App. A, Sec 3.2.4
Monitor Maintenance			
Inlet/downtube Cleaning	1/mo. minimum	cleaned	QA Guidance Document 2.12, Sec 9.3 & 9.4
Pump Replacement	1/18 mos. maximum	Inspected, replaced	per manufacturers' SOP, increase as needed
Inline Filter, Inlet Seal Replacement	Inspect 1/mo., Repl. 1/6 mos.	Replace semi-annually (1/6 mos.)	QA Guidance Document 2.12, Sec 9.4, 9.5 & 9.6
Manufacturer-Recommended Maintenance	per manufacturers' SOP, increase as needed	per manufacturers' SOP, increase as needed	

SYSTEMATIC CRITERIA – PM ₁₀ Continuous			
Data Completeness	monthly	≥ 90%	40 CFR Part 50 App. K, Sec. 2.3
Reporting Units	Hourly concentrations, µg/m ³	µg/m ³ at standard temperature and pressure (STP)	40 CFR Part 50 App. K

Criteria	Frequency	Acceptable Range	Information (CFR or QA Guidance 2.12 ¹⁸)
Rounding Convention			
24-hour average	daily	nearest 1 µg/m ³ (≥ 0.5 round up)	40 CFR Part 50 App. K sec 1
Verification/Calibration Standards and Recertifications - All standards should have multi-point certifications against NIST Traceable standards			
Flow Rate Transfer Std.	1/yr	± 2% of NIST-traceable Std.	40 CFR Part 50, App. J sec 7.3
Field Thermometer	1/yr	± 0.1 °C resolution, ± 0.5 °C accuracy	recommendation
Field Barometer	1/yr	± 1 mm Hg resolution, ± 5 mm Hg accuracy	recommendation
Calibration & Check Standards			
Flow Rate Transfer Std.	1/yr	± 2% of NIST-traceable Std.	QA Guidance Document 2.12, Sec 6.3.2
Verification/Calibration			
Clock/timer Verification	4/year	5 min/mo	recommendation

CRITICAL CRITERIA TABLE - METEOROLOGICAL MEASUREMENT METHODS

S - single instrument hourly value, G - group of hourly values from 1 instrument

Parameter	Criteria	Acceptable Range								Frequency	Samples Impacted	EPA-454/R-99-005 Feb 2000	EPA Regulation & Guidance	ADEC AM&QA QAPP
Method		Measurement Method Characteristics												
		Reporting Units	Range	Accuracy	Resolution	Starting Speed	Distance Constant	Sampling Frequency	Raw Data Collection Frequency					
Wind Speed (WS)	Cup, blade, or heated sonic anemometer	m/s	0.5 m/s - 50 m/s	± 0.2 m/s	0.25 m/s	≤ 0.5 m/s	≤ 0.5 m @ 1.2 kg/m ³	hourly	1 minute	All Data	Ch 2 Sec 1 & 8, Ch 5 Sec 1 & 2, Ch 8 Sec 1	QA Handbook Vol IV Sec 0 Tables 0-3, 0-4, 0-5, 0-6	Section 7 Table A8	
Vertical WS (VWS)			-25 m/s - +25 m/s	± 0.2 m/s	0.1 m/s	≤ 0.25 m/s	≤ 0.5 m @ 1.2 kg/m ³	hourly	1 minute	All Data				
							Damping Ratio						Delay Distance	
WD (azimuth & elevation)	Vane or heated Sonic anemometer	Degrees (°)	1°-360° or 540°	± 5 degrees	1.0 degree	≤ 0.5 m/s @ 10 degrees	0.4 to 0.7 @ 1.2 kg/m ³	hourly	1 minute	All Data			≤ 0.5 m @ 1.2 kg/m ³	
						Time Constant	Spectral Response							
Ambient Temp	Thermistor 10m - 2m	Degrees Celsius (°C)	-40°C to +40°C	± 0.5°C	0.1°C	≤ 1 minute		hourly	1 minute	All Data	Ch 2 Sec 3 & 8, Ch 3 Sec 6, Ch 5 Sec 1&2, Ch 8 Sec 1		Section 7 Table A8	
Vertical Temp Difference (ΔT)			-40°C - +40°C	± 0.1°C	0.02°C	1 minute		hourly	1 minute	All Data				
Dew Point Temperature	Psychrometer/ Hygrometer %	°C	-40°C - +40°C	± 1.5°C	0.1°C	30 minutes		hourly	1 minute	All Data	Ch 2 Sec 4&8, Ch 5 Sec 1&2			
Relative Humidity/			%	0 to 100%	± 7%	0.5 %	≤ 30 minutes		hourly	1 minute				All Data
Barometric Pressure (BP)	Aneroid Barometer	mb	600 mb - 1050 mb Hg	± 3 mb Hg (0.3 kPa)	0.5 mb Hg			hourly	1 minute	All Data	Ch 2 Sec 6 & 8, Ch 5 Sec 1&2			

ADEC – Alaska Department of Environmental Conservation

AM&QA QAPP – Air Monitoring and Quality Assurance QAPP (used by the USEPA to develop the MQO tables for meteorological measurements for Vol. IV guidance document)

CRITICAL CRITERIA TABLE - METEOROLOGICAL MEASUREMENT METHODS													
S - single instrument hourly value, G - group of hourly values from 1 instrument													
Parameter	Criteria	Acceptable Range							Frequency	Samples Impacted	EPA-454/R-99-005 Feb 2000	EPA Regulation & Guidance	ADEC AM&QA QAPP
Solar Radiation	Pyranometer	Watts/m ²	0 - 1300	± 5% of observed	10 W/m ²	5 seconds	285 nm to 2800 nm	hourly	1 minute	All Data	Ch 2 Sec 7 &8, Ch 5 Sec 1&2		
Precipitation	Tipping Bucket (with Alter type windscreen & heater)	mm H ₂ O	0 - 50 mm H ₂ O/hr	± 10% of observed or ± 0.5	0.3 mm H ₂ O			hourly	1 minute	All Data	Ch 2 Sec 5 &8, Ch 5 Sec 1&2		
	Method	Measurement Method Characteristics (continued)											
		Reporting Units	Range	Accuracy	Resolution			Sampling Frequency	Raw Data Collection Frequency				
Vector Data WS	DAS Calculation	m/s	- 50.0 m/s	± 0.2 m/s	0.1 m/s			hourly	1 minute	All Data	Ch 4 Sec 6, Ch 8	QA Handbook Vol IV Sec 0 Tables 0-3, 0-4, 0-5, 0-6	
Vector Data WD	DAS Calculation	Degrees (°)	0 - 360°	± 5°	1.0°			hourly	1 minute	All Data	Ch 4 Sec 6, Ch 8		
sigma theta (σθ)	DAS Calculation SD of azimuth angle of WD	Degrees (°)	0 - 105°	± 5°	1.0°			hourly	15 minute	All Data	Ch 4 Sec 6, Ch 8		Sec 7 Table A8
sigma phi (σϕ)	DAS Calculation SD of vertical component of WS	m/s	0 - 10 m/s	± 0.2 m/s	0.1 m/s			hourly	1 minute	All Data	Ch 4 Sec 6, Ch 8		Sec7 Table A8
		Radiation Range	Flow Rate	Radiation Error	Type	Estimates of Means		Estimates of Variance					
	Motor aspirated temp radiation shield (T, ΔT, RH/Dew Point)	-100 - 1300 W/m ²	3 m/s	< 0.2°C							Ch 2 Sec 3 &4, Ch 8 Sec 1		
Data Acquisition System (DAS)					Micro processor-based digital	1/min for hourly mean (60 samples/hour)		6 samples/min for hourly variance (360 samples/hour)			Ch 4 Sec 6, Ch 8		

CRITICAL CRITERIA TABLE - METEOROLOGICAL MEASUREMENT METHODS							
S - single instrument hourly value, G - group of hourly values from 1 instrument							
	Reporting Intervals						
Parameter	Criteria	Acceptable Range	Frequency	Samples Impacted	EPA-454/R-99-005 Feb 2000	EPA Regulation & Guidance	ADEC AM&QA QAPP
All parameters	Hourly average		Quarterly	All	Ch 5 Sec 1		Sec 7
	Data Completeness						
All parameters	Valid data capture	≥75 %	Hourly	G	Ch 5 Sec 3 & 4	QA Handbook Vol IV Sec 0 Tables 0-3, 0-4, 0-5, 0-6	Sec 7 18 AAC 50.010
	(PSD Quality Monitoring) Valid data capture	≥90% hourly data, joint collection of WS, WD, and stability (σθ or σφ depending upon model selection)	Quarterly (4 consecutive quarters)	G			
	Calibration						
WS, VWS	Multi-point Calibration	5 points including zero, 2 m/s and 3 additional evenly spaced upscale points covering expected wind speeds for the site All test points ≤ ± (2 m/s + 5% of observed) WS bearing torque threshold ≤ PSD quality sensor manufacturer's specs	Initially, 1/6 months thereafter	G	Ch 5	QA Handbook Vol IV All Sections and 0 Tables 0-3, 0-4, 0-5, 0-6	Section 7 MQO Table A8
WS/WD Sonic Anemometer	Multi-point Calibration	Multipoint calibration via wind tunnel by manufacturer	Initially, 1/year thereafter				
WD, VWD	Multi-point Calibration	Alignment to True North + linearity test points at: 0°, 45°, 90°, 135°, 180°, 225°, 270°, 315°, 360° Alignment ≤ ±5° Linearity (All Points) ≤ ± 3° (included in ≤ ± 5° above) WD bearing torque threshold ≤ PSD quality sensor manufacturer's specs	Initially, 1/6 months thereafter	G	Ch 5 Ch 8		

<p align="center">CRITICAL CRITERIA TABLE - METEOROLOGICAL MEASUREMENT METHODS</p> <p align="center">S - single instrument hourly value, G - group of hourly values from 1 instrument</p>							
Parameter	Criteria	Acceptable Range	Frequency	Samples Impacted	EPA-454/R-99-005 Feb 2000	EPA Regulation & Guidance	ADEC AM&QA QAPP
Temp	<u>Multi-point Calibration</u>	Minimum 3 point calibration representative of min avg low to max avg high temps for the location. (e.g., -30°C, 0°C, +30°C) Each point $\leq \pm 0.5^\circ\text{C}$ of NIST Traceable Standard	Initially, 1/6 months thereafter	G	Ch 5 Ch 8		MQO Table, Table A8 Sec 16
ΔT	<u>Multi-point Calibration</u>	Side-by-side calibration of 10m and 2m temp probes with a Minimum 3 point calibration representative of min avg low to max avg high temps for the location. (e.g., -30°C, 0°C, +30°C) Each point $\leq \pm 0.5^\circ\text{C}$ of NIST Traceable Standard and 10m sensor $\leq \pm 0.1^\circ\text{C}$ of 2 m sensor at all points	Initially, 1/6 months thereafter	G	Ch 5 Ch 8		MQO Table, Table A8 Sec 16
RH/Dew point	<u>Multi-point Calibration</u>	Factory multi-point calibration followed by on-site 1-point verification of RH/DP sensor against NIST Traceable RH Standard ($\pm 2\%$ RH accuracy) RH sensor $\leq \pm 7\%$ of RH Standard	Initially, 1/6 months thereafter	G	Ch 5 Ch 8		MQO Table, Table A8 Sec 16
Solar Radiation (SR)	<u>Multi-point Calibration</u>	Factory multi-point calibration followed by on-site zero check with opaque cover 1-point verification against in-cert. First Class collocated Pyranometer SR sensor $\leq \pm 5\%$ of First Class Pyranometer	Initially, 1/6 months thereafter	G	Ch 5 Ch 8		MQO Table, Table A8 Sec 16
Barometric Pressure (BP)	<u>Multi-point Calibration</u>	Factory multi-point calibration followed by on-site 1-point verification against pressure standard of known quality (see pressure std. min requirements) BP sensor $\leq \pm 3 \text{ mb (0.3 kPa)}$	Initially, 1/6 months thereafter	G	Ch 5 Ch 8		MQO Table, Table A8 Sec 16
Precipitation	<u>Multi-point Calibration</u>	Minimum 3 point calibration Each point $\pm 10\%$ of measured H ₂ O input, or $\leq \pm 5 \text{ mm H}_2\text{O}$	Initially, 1/6 months thereafter	G	Ch 5 Ch 8		QA Handbook Vol IV Sec 4 and Sec 0 Tables 0-3, 0-4, 0-5, 0-6
Vector Data/DAS (WS, WD, σ_w , σ_w)	<u>Multi-point Calibration</u>	Calibrate/check DAS voltage input against sensor inputs WS, $\sigma_w \leq \pm 0.2 \text{ m/s}$ WD $\leq \pm 5^\circ$	Initially, 1/6 months thereafter	G	Ch 5 Ch 8	QA Handbook Vol IV Sec 9 and Sec 0 Tables 0-3, 0-4, 0-5, 0-6	

OPERATIONAL EVALUATIONS TABLE - METEOROLOGICAL MEASUREMENT							
S - single instrument hourly value, G - group of hourly values from 1 instrument							
Parameter	Criteria	Acceptance Range	Frequency	Samples Impacted	EPA-454/ R-99-005 Feb 2000	EPA Regulation & Guidance	ADEC AM&QA QAPP
Siting & Exposure Criteria							
All met parameters	Representativeness	Site must be representative for the intent of the monitoring scale , No prescribed quantitative criteria See references	All	All	Ch 3 Sec 1	QA Handbook Vol IV , Section 10-6	
All met parameters	Probe Siting	<i>See references for specific siting criteria for simple, complex, coastal and urban terrain locations</i>	All	All	Ch 3 Sec 2&3		
Calibration/Audit							
WS/ VWS	WS standard Sonic Anemometers calibrated @ factory	NIST Traceable Synchronous motor, or Series of NIST Traceable constant speed motors to generate WS in range of 2 m/s thru 50 m/s		Purchase, recalibrate 1/year or at frequency dependent upon use	G	QA Handbook Vol IV Sec 0 Tables 0-3, 0-4, 0-5, 0-6 Sec 2	Sec 16
WS/WD	Collocated Transfer Standard (CTS) for sonic anemometer audits	CTS must be cup/vane or aerovane anemometer that is calibrated on-site with standards/personnel independent from routine operator/calibration staff and equipment/standards. CTS must meet all PSD quality criteria		Purchase, Calibrate CTS on site prior to conducting each site audit, and CTS collocated for 72 hr minimum	G		
WD/VWD	WD Standard	<p style="text-align: center;">Alignment to True North</p> <ul style="list-style-type: none"> • Solar Noon method, and or • Transit & Compass, map, and site magnetic declination, or • GPS accuracy \leq 3 meters with lock on minimum 3 satellite signals <p style="text-align: center;">Linearity</p> Linearity wheel with evenly spaced preset markings, e.g., 0°, 45°, 90°, 135°, 180°, 225°, 270°, 315°, 360°		Purchase, recalibrate 1/year or at frequency dependent upon use	G		

OPERATIONAL EVALUATIONS TABLE - METEOROLOGICAL MEASUREMENT							
S - single instrument hourly value, G - group of hourly values from 1 instrument							
Parameter	Criteria	Acceptance Range	Frequency	Samples Impacted	EPA-454/R-99-005 Feb 2000	EPA Regulation & Guidance	ADEC AM&QA QAPP
Temperature	Thermister	<ul style="list-style-type: none"> measurement range -50°C to +40°C Accuracy $\leq \pm 0.2^\circ\text{C}$ NIST traceable certified over -30°C to +30°C Resolution $\leq \pm 0.1^\circ\text{C}$ 	Purchase, recertify 1/year or per NIST/ASTM certification frequency	G		QA Handbook Vol IV Sec 3, & Sec 0 Tables 0-3, 0-4, 0-5, 0-6	
RH/Dew Point	RH meter or Assman Style Psychrometer	<p>RH meter NIST Traceable Standard $\pm 2\%$ RH</p> <p>Assman Style Psychrometer with matched pair NIST Traceable/ASTM Thermometers with measurement Resolution 0.1°C each and appropriate temp range No Sling Psychrometer Acceptable</p>	Purchase, recertify 1/year or per NIST traceable certification frequency	G		QA Handbook Vol IV , Sec 5 & Sec 0 Tables 0-3, 0-4, 0-5, 0-6	
Solar Radiation	NIST Traceable Pyranometer	<p>First Class Pyranometer Measurement range Measurement resolution Measurement accuracy</p>	Purchase, recertify 1/year or per NIST traceable certification frequency	G		QA Handbook Vol IV Sec 6 & Sec 0 Tables 0-3, 0-4, 0-5, 0-6	
Barometric Pressure	NIST Traceable Aneroid Barometer	Measurement accuracy $\pm 1\text{mb}$, Measurement resolution 0.1 mb, Measurement range 950 - 1050 mb	Purchase, verify 1/year against NWS-FAA or NIST Traceable Std. or per NIST traceable certification frequency	G		QA Handbook Vol IV Sec 7 & Sec 0 Tables 0-3, 0-4, 0-5, 0-6	Sec 16
Precipitation	Separatory funnel, duated cylinder, and deionized water	<p>Volumetric Glassware Calibrated (50ml or 100 ml, 1 ml divisions), and Deionized H₂O</p>	Purchase	G		QA Handbook Vol IV Sec 5 & Sec 0 Tables 0-3, 0-4, 0-5, 0-6	
	Visual QC Checks-Field						
	Sky Check	Note & Record sky conditions (cloud cover, temp/WS/WD, etc. estimates)	Each site visit	G		QA Handbook Vol IV	

OPERATIONAL EVALUATIONS TABLE - METEOROLOGICAL MEASUREMENT							
S - single instrument hourly value, G - group of hourly values from 1 instrument							
Parameter	Criteria	Acceptance Range	Frequency	Samples Impacted	EPA-454/R-99-005 Feb 2000	EPA Regulation & Guidance	ADEC AM&QA QAPP
WS	WS sensor	Moving freely, no visual damage	Each site visit	G		Sec 10.2	
WD	WD sensor	Moving freely, no visual damage	Each site visit	G			
Temperature, ΔT	Temperature sensors and aspirated temperature shields	No visual damage or obstruction, Motor in aspirated shield working	Each site visit	G			
SR	Solar Radiation Sensor	Radiometer/pyranometer face clear of dirt/debris/snow	Each site visit	G			
BP	Pressure sensor	No visual damage or obstruction	Each site visit	G			
RH	RH sensor, aspirated shield	S	Each site visit	G			
Precipitation	Precipitation sensor	No visual damage or obstruction, free of ice and snow, Heater working	Each site visit	G			
DAS	Data Acquisition System	DAS time ≤ 1 minute NIST Alaska Standard aaTime1	Each site visit	G			
Data Screening Criteria							
WS/ VWS	Hourly Recorded WS	0 m/s ≥ WS ≤ 25 m/s, WS varies ≥ 0.1 m/s/3 consecutive hours, WS varies ≥ 0.5 m/s/12 consecutive hours, or per site specific climatology criteria	1/week or more frequent	G	Ch 8, Table 8-4	QA Handbook Vol IV Sec 10.4	
WD/VWD	Hourly Recorded WD	0° ≥ WD ≤ 360°, WD varies ≥ 1°/3 consecutive hours, or per site specific climatology criteria	1/week or more frequent	G	Ch 8, Table 8-4		
Temperature	Hourly Recorded Ambient Temperature	Local record low ≥ Temp ≤ local record high, Temp ≤ 5°C from previous hourly record, Temp varies ≥ 0.5°C/12 consecutive hours, or per site specific climatology criteria	1/week or more frequent	G	Ch 8, Table 8-4		
10m - 2 m ΔT	Hourly Recorded 10m -2m Temperature Difference	Day time ΔTemp < 0.1°C/m, Night time ΔTemp > -0.1°C/m, -3.0°C > ΔT < 5.0°C, or Per site specific climatology criteria	1/week or more frequent	G	Ch 8, Table 8-4		

OPERATIONAL EVALUATIONS TABLE - METEOROLOGICAL MEASUREMENT							
S - single instrument hourly value, G - group of hourly values from 1 instrument							
Parameter	Criteria	Acceptance Range	Frequency	Samples Impacted	EPA-454/R-99-005 Feb 2000	EPA Regulation & Guidance	ADEC AM&QA QAPP
RH/Dew Point	Hourly Recorded Relative Humidity	Dew Point Temp ≤ Ambient Temp for time period, Dew Point Temp < 5°C change from previous hour, Dew Point Temp ≥ 0.5°C from previous hour, and Dew Point Temp < Ambient Temp for 12 consecutive hrs.	1/week or more frequent	G	Ch 8, Table		
Solar Radiation	Hourly Recorded Solar Radiation	Night time SR = 0, Day time SR < max SR for date and latitude	1/week or more frequent	G	Ch 8, Table		
Barometric Pressure	Hourly Recorded Barometric Pressure	BP < 1050 mb (sea level), BP > 945 mb (sea level), or Per site specific climatology criteria	1/week or more frequent	G	Ch 8, Table		
Precipitation	Hourly Recorded Precipitation	Note: Develop site specific climatology criteria for each season	1/week or more frequent	G	Ch 8, Table		
	Maintenance						
WS/VWS	Sensor bearings	Replace	1/6 months	G			
WD/VWD	Sensor Bearings	Replace	1/6 months	G			
SR		Per manufacturer's recommendations	Per manufacturer's recommendations	G			
DAS	Data Acquisition System (internal battery back-up)	Check Battery Back-up, Replace as needed	1/6 months	G			
	Bias/Accuracy						
WS, VWS	Performance Audit	5 points including zero, 2 m/s and 3 additional evenly spaced upscale points covering expected wind speeds for the site Audit points ≤ ± (2 m/s + 5% of observed) WS bearing torque threshold ≤ PSD quality sensor Manufacturer's specs		G	Ch 5	QA Handbook Vol IV Sec 2.7	Sec 7 MQO Table A8

OPERATIONAL EVALUATIONS TABLE - METEOROLOGICAL MEASUREMENT							
S - single instrument hourly value, G - group of hourly values from 1 instrument							
Parameter	Criteria	Acceptance Range	Frequency	Samples Impacted	EPA-454/R-99-005 Feb 2000	EPA Regulation & Guidance	ADEC AM&QA QAPP
WS/WD (Sonic Anemometer)	Performance Audit	Collocated for minimum 72 hrs with on-site calibrated cup/vane or aerovane anemometer CTS WS criteria <ul style="list-style-type: none"> • $\leq \pm 0.2$ m/s + 5% observed CTS • SD of differences $\leq \pm 0.2$ m/s • Qualifications WS > 1 m/s WD criteria <ul style="list-style-type: none"> • $\leq \pm 5^\circ$ observed CTS • SD of differences $\leq \pm 2^\circ$ • Qualifications WS > 1 m/s 	NCORE/SLAMS 1/year SPM 1/yr (suggested) PSD Every sensor within 30 days of start-up and 1/6 months thereafter			QA Handbook Vol IV Sec 2.7.3.2 CTS Method	
WD, VWD	Performance Audit	Alignment to True North + linearity audit points at: 0°, 45°, 90°, 135°, 180°, 225°, 270°, 315°, 360° Alignment $\leq \pm 5^\circ$ Linearity (All Points) $\leq \pm 3^\circ$ (included in $\leq \pm 5^\circ$ above) WD bearing torque threshold \leq PSD quality sensor manufacturer's specs		G	Ch 5 Ch 8	QA Handbook Vol IV Sec 2.7	MQO Table, Table A8 Sec 16
Vector Data/DAS (WS, WD, σ_w , σ_{ws})	Performance Audit	WS $\leq \pm 0.2$ m/s WD $\leq \pm 5^\circ$		G		QA Handbook Vol IV Sec 2.8	
Temp	Performance Audit	Minimum 3 point audit representative of min avg low to max avg high temps for the location. (e.g., -30°C, 0°C, +30°C) Each point $\leq \pm 0.5^\circ\text{C}$ of NIST Traceable Standard		G	Ch 5 Ch 8	QA Handbook Vol IV Sec 3.6	MQO Table, Table A8 Sec 16

OPERATIONAL EVALUATIONS TABLE - METEOROLOGICAL MEASUREMENT							
S - single instrument hourly value, G - group of hourly values from 1 instrument							
Parameter	Criteria	Acceptance Range	Frequency	Samples Impacted	EPA-454/R-99-005 Feb 2000	EPA Regulation & Guidance	ADEC AM&QA QAPP
ΔT	Performance Audit	Side-by-side audit of 10m and 2m temp probes with a minimum 3 point audit representative of min avg low to max avg high temps for the location. (e.g., -30°C, 0°C, +30°C) Each point $\leq \pm 0.5^\circ\text{C}$ of NIST Traceable Standard and 10m sensor $\leq \pm 0.1^\circ\text{C}$ of 2 m sensor at all points		G	Ch 5 Ch 8	QA Handbook Vol IV Sec 3.6	MQO Table, Table A8 Sec 16
RH/Dew point	Performance Audit	1-point audit of RH/DP sensor against NIST Traceable RH Standard ($\pm 2\%$ RH accuracy) RH sensor $\leq \pm 7\%$ of RH Standard		G	Ch 5 Ch 8	QA Handbook Vol IV Sec 5	MQO Table, Table A8 Sec 16
Solar Radiation (SR)	Performance Audit	1-point audit against in-cert. First Class Pyranometer SR sensor $\leq \pm 5\%$ of First Class Pyranometer		G	Ch 5 Ch 8	QA Handbook Vol IV Sec 6	MQO Table, Table A8 Sec 16
Barometric Pressure (BP)	Performance Audit	1-point audit against pressure standard of known quality (see pressure std. min. requirements) BP sensor $\leq \pm 3 \text{ mb}$ (0.3 kPa)		G	Ch 5 Ch 8	QA Handbook Vol IV Sec 7	MQO Table, Table A8 Sec 16
Precipitation	Performance Audit	Minimum 3 point audit Each point $\leq \pm 10\%$ of measured H_2O input, or $\leq \pm 5 \text{ mm H}_2\text{O}$		G	Ch 5 Ch 8	QA Handbook Vol IV Sec 4	MQO Table, Table A8 Sec 16

ADEC – Alaska Department of Environmental Conservation

AM&QA QAPP – Air Monitoring and Quality Assurance QAPP (used by the USEPA to develop the MQO tables for meteorological measurements for Vol. IV guidance document)

SYSTEMATIC ISSUES TABLE - METEOROLOGICAL MEASUREMENT METHODS S - single instrument hourly value, G - group of hourly values from 1 instrument							
Parameter	Criteria	Acceptable Range	Frequency	Samples Impacted	EPA-454/R-99-005 Feb 2000	EPA QA Handbook Volume IV	ADEC AM&QA QAPP
	Data Completeness						
All Met Parameters		≥ 75% NCore, SLAMS, SPM ≥ 90%, Windblown Dust OTM	Quarterly Monthly	G			
	QC Checks						
	DAS Clock/timer Verification	≤ ± 1 minute.	Each site visit weeks	G			
	Bias/Accuracy						
All Met parameters	Technical Systems Audit	NCore/SLAMS/SPM networks	1/3 years.	G		QA Handbook Vol IV Sec 10 & App. A	
		PSD, Windblown Dust OTM	Within 1 month of start-up and semi-annually thereafter	G			

ADEC – Alaska Department of Environmental Conservation

AM&QA QAPP – Air Monitoring and Quality Assurance QAPP (used by the USEPA to develop the MQO tables for meteorological measurements for Vol. IV guidance document)

Appendix C Sand Motion Measurement Quality Objectives Validation Template

MQOs for sand motion monitoring conducted for this method should follow the guidance in the 2008 Owens Valley PM10 Planning Area State Implementation Plan (2008 OVPA SIP, Chapter 8 Attachment C).

CRITICAL CRITERIA TABLE - SAND MOTION MEASUREMENT METHODS									
Parameter	Criteria	Acceptable Range						Samples Impacted	Guidance 2008 OVPA SIP
	Method	Measurement Method Characteristics							
		Reporting Units	Range	Sensitivity	Resolution	Sampling Frequency	Raw Data Collection Frequency		
Sensit	Particle Count Average (PC)	PC	2.00E+20	1x, 10x		2-sec.	5-min.	All Data	SIP Ch. 8, Att. C
		PC	2.00E+20	1x, 10x		2-sec.	hourly	All Data	SIP Ch. 8, Att. C
	Kinetic Energy (KE)	KE	1.00E+05	1x, 10x		2-sec.	5-min.	All Data	SIP Ch. 8, Att. C
		KE	1.00E+05	1x, 10x		2-sec.	hourly	All Data	SIP Ch. 8, Att. C
	Height to center of sensor	cm	15±1cm	0.1 cm	0.1 cm	every site visit	every site visit	All Data	SIP Ch. 8, Att. C
	Data logger clock time	minutes	NA	1 second	1 second	2-sec.	every site visit	All Data	SIP Ch. 8, Att. C
	Sampling Period	minutes	NA	1 second	1 second	5±1 min.	every site visit	All Data	SIP Ch. 8, Att. C
Cox Sand Catcher	Mass	grams	5 kg	0.1 grams	0.01 grams	monthly	per wind event	All Data	SIP Ch. 8, Att. C
	Height to center of inlet	cm	15±1cm	0.1 cm	0.1 cm	every site visit	every site visit	All Data	SIP Ch. 8, Att. C
Field Balance	Mass	grams	5 kg	1 gram	1 gram	every site visit	every site visit	All Data	SIP Ch. 8, Att. C
	Mass Calibration	grams	5 kg	1 gram	1 gram	beginning and end of each mass processing day	beginning and end of each mass processing day	All Data	SIP Ch. 8, Att. C
	Mass Calibration Check	grams	150 gms	1 gram	1 gram	every site visit	every site visit	All Data	SIP Ch. 8, Att. C
Lab Balance	Mass	grams	5 kg	0.1 gms	0.01 gms	every mass processing day	every mass processing day	All Data	SIP Ch. 8, Att. C
	Re-weigh 10% of all sand catch samples	grams	5kg	0.1gms	0.01 gms	every mass processing day	every mass processing day	All Data	SIP Ch. 8, Att. C
	Mass Calibration, Min. 3 points + zero over range of expected sample masses	grams	5kg	0.1 gms	0.01 gms	beginning and end of each mass processing day	beginning and end of each mass processing day	All Data	SIP Ch. 8, Att. C

OPERATIONAL EVALUATIONS TABLE - SAND MOTION MEASUREMENT METHODS					
Parameter	Criteria	Acceptance Range	Frequency	Samples Impacted	Guidance 2008 OVPA SIP
Sensit PC	Response Verification	Any response acceptable	Every site visit	All sites	SIP Ch. 8, Att. C
Sensit KE	Response Verification	Any response acceptable	Every site visit	All sites	SIP Ch. 8, Att. C
	KE Background	Background response must be consistent to use KE to calculate ratios to sand catch	Every Sensit	All sites	SIP Ch. 8, Att. C
Sensit PC, KE	Sampling interval	All intervals accounted for	Every sample	All Samples	SIP Ch. 8, Att. C
	Elevated Sensit Response	Total output for day coincide with upscale wind events	Daily	All sites	SIP Ch. 8, Att. C
	Sensit Response	Relationship between KE, PC should be linear, if not, PC saturation may have occurred	Daily	All sites	SIP Ch. 8, Att. C
	Deviation	Deviations >10x the PC or KE to sand catch ratio, Investigate/Flag	Every sample	All Samples	SIP Ch. 8, Att. C
	Zero Response	Response > 0 at low (<5m/s) or no wind speed, investigate	Every sample	All Samples	SIP Ch. 8, Att. C
	Sensit Response	Response > 0 at temperatures <0°C and low (<5m/s) or no wind speed, investigate	Every sample	All Samples	SIP Ch. 8, Att. C
	Duplicate Interval Data	Investigate all duplicate interval data for logger malfunction	Every sample	All Samples	SIP Ch. 8, Att. C
Sand Catch	Wet Sample Mass	Wet Samples weighed, then dried @ ≤80°C, then weighed again for data of record	All Wet Samples	All Wet Samples	SIP Ch. 8, Att. C

SYSTEMATIC CRITERIA TABLE - - SAND MOTION MEASUREMENT METHODS					
Criteria	Frequency	Acceptable Range	Frequency	Samples Impacted	Guidance 2008 OVPA SIP
Sensit Data Completeness	Monthly	<u>All</u> monitoring intervals must be accounted for	Weekly	All Data	SIP Ch. 8, Att. C
Sand Catcher Data Completeness	Monthly	<u>Every</u> Sensit <u>must</u> have an associated sand catcher	Monthly	All Data	SIP Ch. 8, Att. C

2008 OVPA SIP – 2008 Owens Valley PM₁₀ Planning Area Demonstration of Attainment State Implementation Plan ⁴

Appendix E

Comments from the Los Angeles Department of Water and Power



ANTONIO R. VILLARAIGOSA
Mayor

Commission
THOMAS S. SAYLES, *President*
ERIC HOLOMAN, *Vice President*
RICHARD F. MOSS
CHRISTINA E. NOONAN
JONATHAN PARFREY
BARBARA E. MOSCHOS, *Secretary*

RONALD O. NICHOLS
General Manager

May 29, 2012

Conniesue Oldham, Ph.D.,
Group Leader – Measurement Technology Group
U.S. Environmental Protection Agency
109 T.W. Alexander Drive
Research Triangle Park, NC 27711

Dear Dr. Oldham:

Subject: Appearance of Other Test Method 30 - Method to Quantify Particulate Matter Emissions from Windblown Dust on U.S. Environmental Protection Agency's Technology Transfer Network Emission Measurement Center

This letter responds to your letter dated April 17, 2012, providing the Los Angeles Department of Water Power (LADWP) an opportunity to provide the U.S. Environmental Protection Agency (EPA) with information as to the inappropriateness of identifying Other Test Method 30 (OTM 30) as a potential test method. OTM 30 is the Great Basin Unified Air Pollution Control District's (Great Basin) Dust Identification Model (Dust ID model), which utilizes CALMET/CALPUFF for its plume dispersion modeling. The initial report describing OTM 30 was posted on the EPA's Technology Transfer Network (TTN)¹ on March 12, 2012, but was removed on April 20, 2012, pending further review by the EPA. In keeping with EPA policy,² LADWP is submitting these comments as well as additional field and laboratory data that call into question some of the findings in the original posting.

Even though EPA has not approved CALPUFF for "near-source" or "near-field" assessments as it is used in the Dust ID model, non-EPA staff has represented to LADWP that EPA has approved the Dust ID model. The inclusion of OTM 30 on EPA's website has been further misinterpreted as proof that EPA has approved the Dust ID Model. LADWP appreciates your clarification that OTM 30 is not approved by EPA and would have to be subjected to a federal rulemaking process before it could be approved.

Unfortunately, the technical acceptability of OTM 30 is undermined by errors and inaccuracies scattered throughout the document, by the subjective nature of some of the calculations, by the insufficient user guidance, and by the insufficient performance evaluation, which is far too narrow in scope to properly verify this method with the potential for widespread and varied use. These deficiencies, presented in this letter below and in the enclosure, should be addressed before EPA considers reposting OTM 30. LADWP strongly recommends that the EPA conduct its own third-party review of OTM 30 to ensure that the proper levels of validation and documentation are provided, including the discussions pertaining to

¹ EPA Technology Transfer Network, Emission Measurement Center, Other Methods website:
<http://www.epa.gov/ttn/emc/prelim.html>

² EPA's Interim Policy for Posting Methods, Category C Method

Water and Power Conservation ... a way of life

111 North Hope Street, Los Angeles, California 90012-2607 Mailing address: Box 51111, Los Angeles 90051-5700
Telephone: (213) 367-4211 Cable address: DEWAPOLA

recommended applications and limitations of the method. While we understand from your letter the purpose of posting OTM 30 on the EPA website, LADWP requests that OTM 30 not be included in EPA's TTN Emission Measurement Center because: (1) the OTM 30 model has not been evaluated as required by 40 C.F.R. Part 51, Appendix W, § 3.2.2.(a) and EPA Clarification Memo dated August 13, 2008; (2) OTM 30 requires the calibration of CALPUFF with its own results in violation of EPA modeling rules (40 C.F.R. Part 51, Appendix W, § 7.2.9); (3) a two-year objective scientific peer review of the Dust ID model shows that the Dust ID model cannot accurately predict PM10 concentrations in time and space; and (4) the recommended specific changes that were deemed necessary to address specific severe deficiencies in the Dust ID model have never been implemented. As discussed further below, OTM 30 is not a "useful" research method and its appearance on the EPA website would be misinterpreted as giving the method the appearance of scientific or technical acceptability.

It is worth noting that OTM 30, an EPA Category C method, has not been subject to the federal rule-making process, yet it is still considered a candidate for use in federally enforceable state and local programs, as well as in state permitting programs and scientific and engineering applications that do not require EPA oversight. OTM 30 should not be used until it has been subjected to the federal rule-making process. For these reasons, OTM 30 should be much more thoroughly vetted before reposting.

Background

OTM 30 was developed in 2011 and early 2012 by the Center for Study of Open Source Emissions (CSOSE), a public/private partnership of agencies, academic institutions, industry associations, and consulting firms led by Dr. Chatten Cowherd, Midwest Research Institute. Mr. Duane Ono, Great Basin, was the chair of the OTM 30 development committee, with assistance from several other members, including Mr. David James of the University of Nevada-Reno, Mr. Richard Countess of Countess Environmental, and others. LADWP's decision to formally critique OTM 30 arose only after the method had been posted on the TTN website. Many of the concerns expressed in this letter are the same as those provided to Great Basin over the years regarding the Dust ID model, which (as described below) is the prototype for OTM 30.

OTM 30 differs only slightly from the Great Basin's Dust ID model, which was developed by the Great Basin and is currently used to identify supplemental dust control areas on Owens Lake, California. The Dust ID model is also used to demonstrate the effectiveness of the 2008 State Implementation Plan (SIP) dust control strategy within the Owens Valley Planning Area (OVPA). The single greatest difference between OTM 30 and the Dust ID model is that OTM 30 calls for the use of an upwind monitor whereas the Dust ID model does not. Upwind monitors are needed to account for incoming (upwind) particulate matter (PM) masses that would otherwise be falsely attributed to site emissions. The current Dust ID modeling protocol does not account for the concentration difference between upwind and downwind monitors, nor is there in place a screening criterion (or criteria) designed to prevent high incoming PM concentrations from being falsely attributed to emissions from the Owens playa. LADWP has long sought

relief from the Great Basin on this particular issue, but all requests for a formal change have been denied. Recently, the Great Basin has begun removing individual high upwind concentration events from the emission rate calculations on a case-by-case basis, but only when requested by LADWP.

OTM 30 and the Dust ID model have much in common, and they share many of the same deficiencies. Some, but not all, of these deficiencies are covered in this document.

LADWP is familiar with the Dust ID model, as for nearly ten years, LADWP and its consultants have reviewed the Great Basin's model runs and investigated ways to improve the performance of the Dust ID model, which has little to no predictive capability. LADWP's efforts have been met with relatively little cooperation from the Great Basin. From February 2008 through May 2010, LADWP and Great Basin staff met with a panel of third-party experts as required by the 2006 Settlement Agreement between the City of Los Angeles and the Great Basin (2006 Settlement Agreement). Dr. Chatten Cowherd, head of the CSOSE, was one of the three experts chosen by mutual consent. The purpose of the Expert Panel is explained in the 2006 Settlement Agreement as follows:

"The Parties will work cooperatively, with the participation of a mutually agreeable independent third party technical expert or experts under contract to the District and jointly managed by the Parties, in a good faith effort to develop, before April 1, 2010, an improved Dust ID Program. The APCO [Air Pollution Control Officer] will implement all mutually-agreeable changes to the Dust ID Program and notify the City in writing of those changes."

The Expert Panel was selected and convened in early 2007 and continued to meet periodically with LADWP and the Great Basin through spring 2010. On May 11, 2010, the Expert Panel published their final set of findings, which included 28 recommendations for both better understanding and improving the model. In a unilateral decision, the Great Basin chose to implement only 3 of the 28 recommendations, and further, refused to discuss any additional refinements to the Dust ID model with LADWP or the experts. As a result of the Great Basin's intransigence, the Dust ID model is relatively unchanged from the version used before 2006. In an April 2011 model performance evaluation using data from July 2006 through June 2010, LADWP demonstrated that the Dust ID model has little or no predictive capability across the majority of the Owens playa, the one exception being a one-square-mile emissive area on the northeast side of the playa. OTM 30 is based largely on this version of the Dust ID model, with a few changes that are noted herein.

Technical Shortcomings of the OTM 30 Methodology and Report

The OTM 30 methodology and report contain many technical shortcomings, as summarized below:

1. The OTM 30 report contains numerous errors and inconsistencies.
2. Elements of the OTM 30 methodology are highly subjective.
3. The OTM 30 report is missing important information and lacks adequate user guidance.

4. The OTM 30 report lacks a clear and concise set of data screening criteria.
5. The OTM 30 methodology relies on "back calculation" to determine emission rates.
6. The OTM 30 performance evaluation is too narrowly focused and biased.

Each of these issues is explored in more detail as follows.

Issue 1: OTM 30 Report Contains Errors and Inconsistencies

The OTM 30 report contains numerous errors and inconsistencies, including the following:

Section 1.1, Introduction: The statement that: "*The method relies on comparing saltation flux to the difference in upwind and downwind ambient PM concentrations to quantify PM emissions*" is incorrect because it implies that OTM 30 uses a relationship to compute PM_{10}^3 emission rates as a function of saltation flux and PM_{10} concentration difference. No such relationship exists. More accurately, OTM 30 relies on a comparison of modeled and observed PM_{10} concentrations to determine the emission rates, and the saltation fluxes are used to weight the emissions from the source areas in the model.

It is very important to note that the monitoring of saltation fluxes must occur throughout the entire region between the upwind and downwind PM_{10} monitors. This is critical to ensure that the PM_{10} differences are attributed to the known sources lying between the upwind and downwind monitors. If there are unknown sources producing emissions between the upwind and downwind monitors, they will be *falsely attributed* to the known sources. The user documentation must make this point more clear; it is one of the greatest potential sources of error in the method.

Section 1.2, Applicability: The statement that the method "*...can be applied to any open surface area susceptible to wind erosion where saltation flux can be measured*" is too general and must be qualified. It would be appropriate to say that the method may be applied to any open surface area susceptible to wind erosion where saltation flux can be measured, *which has been properly instrumented to reflect the spatial and temporal variability on the site, and where the data have been properly screened to ensure a high-quality data set for analysis.*

Section 2.1, Principle: This statement that: "*This test method can be applied to determine dust emissions as PM_{10} , $PM_{10-2.5}$, or $PM_{2.5}$* " is not supported by scientific literature. The K-factor methodology that underlies OTM 30 is based on the premise that a linear relationship exists between PM_{10} flux and saltation flux. It is not known whether this assumption holds for $PM_{2.5}$ flux or $PM_{10-2.5}$ flux. Before extending OTM 30 to these additional size classes, it should be first demonstrated that a linear relationship exists between $PM_{2.5}$ flux (and $PM_{10-2.5}$ flux) and saltation flux.

Section 2.2, History of the Methodology: Just after presenting Equation 1, the OTM 30 report states: "*Note that size-specific K-factors can be calculated for PM_{10} , $PM_{10-2.5}$ or $PM_{2.5}$, depending on the type of*

³ Particulate matter less than 10 microns in diameter

particulate monitor used for PM measurements. These studies also found that different soil textures and chemistries can affect K-factors."

The second sentence is an exaggeration. To our knowledge, there are no studies linking K-factors to differences in soil texture or chemistry. In the Dust ID modeling on Owens Lake, arguably the most extensive application of the OTM 30 method available, the 110-square-mile Owens playa was stratified into broad spatial classes of "North Area," "Central Area," and "South Area." Within each of these spatial groups, multiple soil textures and chemistries were aggregated into a single set of K-factors, but no effort was made to differentiate the K-factors by soil type, texture, or chemistry.

Section 2.6, Dispersion Modeling: The statement that: "...CALPUFF is commonly applied to near-field dispersion and long-range transport situations where the three-dimensional qualities of the wind field are important..." is misleading because it suggests that CALPUFF may be used interchangeably with AERMOD for near-field dispersion modeling applications. CALPUFF is not the recommended model (AERMOD is), but may be approved in advance for near-field applications if certain conditions are met, as explained in an EPA technical memorandum:⁴

"The basic requirements for justifying use of CALPUFF for near-field regulatory applications consist of three main components:

- 1) a determination that treatment of complex winds is critical to estimating design concentrations;*
- 2) A determination that the preferred model (AERMOD) is not appropriate or less appropriate than CALPUFF; and*
- 3) a demonstration that the five criteria listed in paragraph 3.2.2(e) of the Guideline for use of CALPUFF as an alternative model are adequately addressed.*

Each of these steps involves case-specific considerations."

The OTM 30 report should clarify these requirements and note that the necessary approvals must be obtained in advance.

Section 3.0, Definitions: Section 3.3 defines K-factors as "*the ratio of the vertical dust flux to the horizontal saltation flux.*" This is incorrect. K-factors are proportionality constants representing the ratio of observed and predicted particulate matter concentrations at a downwind monitor.

Section 3.6 defines sand catchers as "*...devices, such as the Cox Sand Catcher that are used to measure saltation flux over a given period...*" This is incorrect. Sand catchers are passive sand collection

⁴ "Technical Issues Related to CALPUFF Near-field Applications." Technical memorandum from Roger W. Brode, U.S. EPA, OAQPS, Air Quality Modeling Group to Tyler Fox, Leader, U.S. EPA, OAQPS, Air Quality Modeling Group, dated September 26, 2008. 13 pp.

devices used to measure sand mass at a fixed location. Sand fluxes are calculated by apportioning the sand mass collected in a sand catcher using the time-dependent output from a Sensit.

Section 3.7 defines a Sensit as "...an electronic sensor that provides a relative reading of sand flux over time. It is used to time-resolve sand catch mass using the linear relationship between Sensit reading and saltation flux to determine hourly sand flux rates." This statement is incorrect on two counts. First, Sensits provide a relative reading of sand motion over time, which is recorded either as kinetic energy or particle count. Sensits do not provide a "relative reading of sand flux"; to do that, the sand fluxes must be known first by time-resolving the captured sand mass using the Sensit output. Second, Sensits are not "used to time-resolve sand catch mass using the linear relationship...": it is the Sensit output itself, not a linear relationship, which is used to time-resolve the sand masses to determine the hourly sand flux. The "linear relationship" that is referred to here has been used by the Great Basin occasionally in the past to calculate sand fluxes on Owens Lake in lieu of collecting sand mass with sand catchers. However, there are several pitfalls with this approach: (1) the relationship is instrument-specific, (2) the instrument-specific relationship is not always linear or well correlated, and (3) the relationship must be determined in advance for the surface of interest. For all these reasons, there is little value in this practice and we do not recommend it.

Section 7.1.1, Sensit and CSC Monitor Locations: "The density of the sand flux monitoring network is left to the user depending on the available resources for the project." This statement is scientifically indefensible and should be removed or reworded. The Data Quality Objectives (DQOs), not the availability of resources, should dictate the density of the sand-flux monitoring sites as well as other elements of the network design. DQOs are critical at the project planning stage to ensure that the type, quantity, and quality of data needed to reach defensible decisions or make credible estimates are collected (see additional comments on OTM 30 Section 1.3, listed under Issue No. 3 of this document).

Section 7.1.1, Sensit and CSC Monitor Locations: Paragraph 4 of this section starts with: "Collocated studies with the Cox Sand Catchers (CSC) have been conducted that demonstrate the precision of the instruments to be within +3%." This statement is probably only true on sandy surfaces where data have been collected and averaged over long time periods. The variability in PM emission rates for bare surfaces on Owens Lake, for example, has been shown to be much greater than three percent. For example, Ono (2002)⁵ found that for 1-2 week periods, the sampling error was about 60 percent for single CSC samples representing one square kilometer each.

Section 7.1.1, Sensit and CSC Monitor Locations: Paragraph 4 states that: "Since precision is effectively determined by comparison of the modeled concentrations calculated from Sensit/CSC data with the monitored data collected at the PM monitoring stations, the need for collocated Sensit/CSC sand motion

⁵ Ono, D. 2002. Comparative Sand Flux Measurements Using BSNE and Cox Sand Catchers on the South Sand Sheet of Owens Dry Lake; 1/4/00 thru 7/30/00. Paper submitted to the Owens Lake Expert Panel on February 2, 2010.

monitors is not necessary." This is incorrect. The distribution of points on an X:Y plot does not depict *precision* (that is, repeatability), it depicts *accuracy*. Precision is best evaluated using collocated monitors. Data from collocated monitors provides vital information on the spatial variability of a site, and how well the sand-flux monitoring network matches that variability.

Issue 2: Elements of the OTM 30 Methodology are Highly Subjective

The OTM 30 methodology is highly subjective, creating a possible situation where different modelers working on the same project might calculate different emission rates. The single greatest source of subjectivity is in the assignment of seasonal K-factor cut-points:

Section 12.0, Sample Application: *"Several seasonal K-factor cut-points were selected based on shifts observed in K-factor values." "Seasonal K-factors were applied to the hourly sand flux to calculate hourly PM₁₀ emissions using Equation 4."*

As is true for the Great Basin's Dust ID model, the process of selecting seasonal cut-points in OTM 30 is highly subjective because it relies on simple visual cues to group K-factors by magnitude, which are then attributed to different "seasons." The method does not include any independent measurements or observations to verify that "seasons" are real, or that the breaks (cut-points) between the seasons reflect genuine shifts in surface conditions that lead to different emission rates (for example, higher temperatures in summer are known to produce more durable, less erodible crusts with lower emission rates).

It is a fundamental flaw in OTM 30 and the Dust ID model to assume that changes in K-factors are caused solely by seasonal changes in surface conditions; they are not. Some of the K-factor variation is due to changes in surface conditions and emissions. But much of the variation is caused by the errors and uncertainties that are inherent in the modeling process. Errors in the source configuration, errors in the wind field, unrepresentative sand fluxes, high background concentrations that are not removed from the model, and more, all contribute to a part of the K-factor variation that is not attributable to surface changes. It is a mistake to group values by "season" without some independent means of assessing whether the changes are due to surface changes, or to these other factors.

Interestingly, the model performance is *improved* by grouping K-factors on the basis of magnitude, without regard for whether the K-factor groups represent different surface conditions or not. The reason is that OTM 30 and the Dust ID model both work by matching the model predictions to the observations on an hour-by-hour basis. The closer one gets to the original hour-by-hour calibration, the better the model performance. So, grouping the high values, low values, and medium values together produces better model performance results than, say, taking an average of all the K-factors. In this case, good model performance rewards the wrong practice.

The arbitrariness of the seasonal cut-point selection process is exemplified in Figures 1a, 1b, and 1c. Figure 1a shows the temporal distribution of Dust ID model K-factors with no cut-point lines for the

Figure 1. Example showing initial K-factors with no seasonal cut-point lines (a), a single “season” representing the entire period (b), and the seasonal cut-point actually chosen by Great Basin (c).

Figure 1a

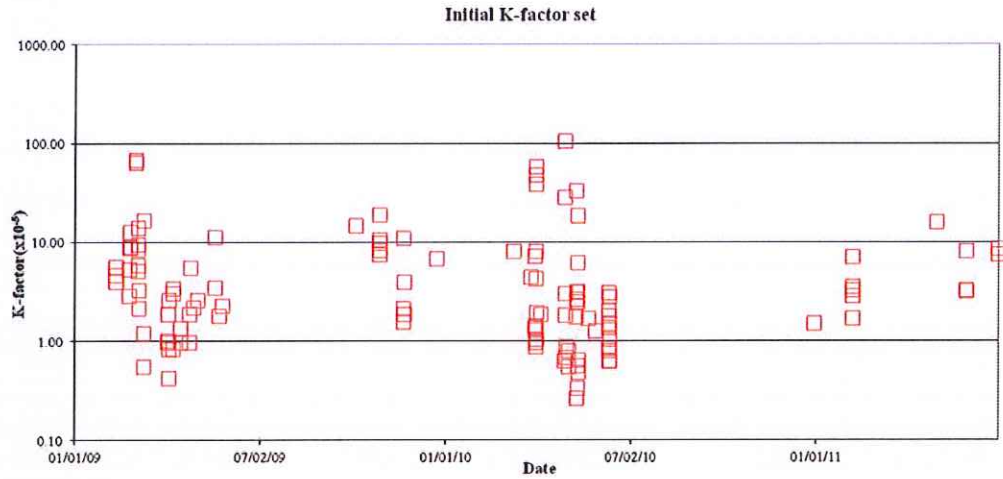

Figure 1b

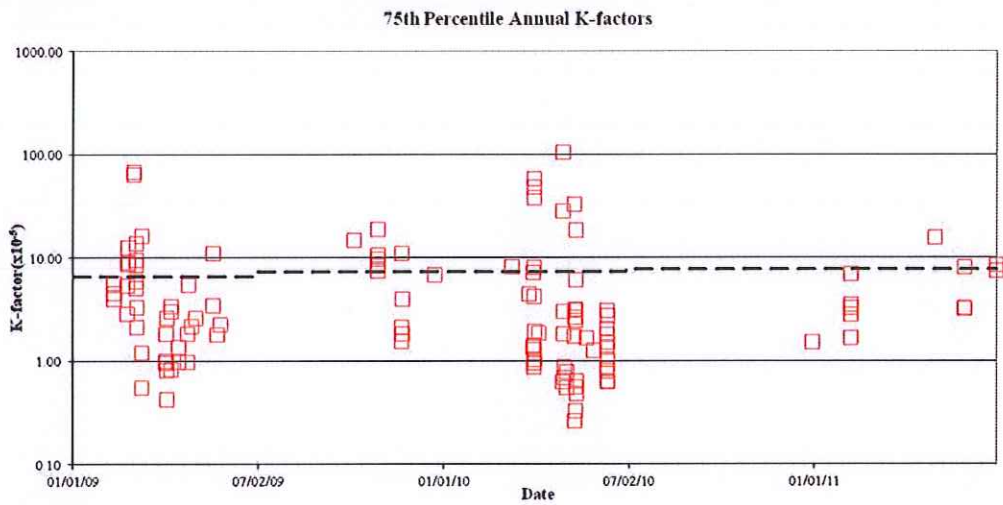
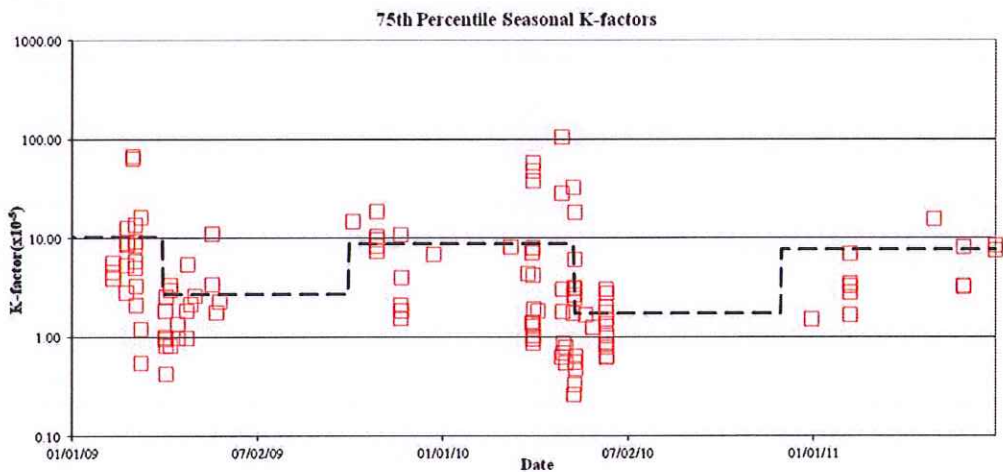

Figure 1c



southern area on Owens Lake. Because the K-factor distribution in Figure 1a shows a high degree of variability but no discernible “step” that would suggest a change in seasonal surface conditions, it would be reasonable in this case to assume that there is no seasonal break and to average over the entire year (Figure 1b). Figure 1c shows the seasonal cut-point actually selected by the Great Basin for this particular data set. It is not clear why the Great Basin chose to stratify the data in this manner, but we suspect that the cut-points were adjusted forward and backward to achieve a minimum of nine data points within a “season.” If fewer than nine points are available, the 2008 SIP requires that the default K-factors (which are much lower in value) be used.

The K-factor cut-point selection process is highly subjective, creating the possibility that different modelers will calculate different results for the same site. The method cannot be objectively applied. This is a fundamental flaw in OTM 30 that may be aided but not cured with better and more complete user guidance. A different approach for computing K-factors is needed. At the least, the new approach should involve some degree of surface observations and measurements.

Issue 3: OTM 30 is Missing Information and Lacks Specific User Guidance

The OTM 30 report is missing some key information that users need to implement the approach. In addition, there is insufficient information to guide the user in making sound decisions about the use of OTM 30, including the ability to recognize and thereby avoid some of the key shortcomings of this method. There is limited guidance to assist users in assigning the proper numbers, types, and placement of monitors. Guidance is also needed to assist users in knowing when, where, and how to apply the method. The application of the method will be different depending on the setting.

A few detailed comments are presented below.

Section 1.3, Data Quality Objectives (DQOs): Section 1.3 simply recites portions of 40 CFR Part 58, Appendix B, but provides no specific guidance on which DQOs might be appropriate for using OTM 30 to compute emission rates from surfaces. DQOs are used at the front-end of a project to ensure that the type, quantity, and quality of data needed to reach defensible decisions or make credible estimates are collected. Ultimately, the DQOs drive the overall sampling approach and intensity. This section should be rewritten to paraphrase the DQO development process, with appropriate links to the EPA’s Guidance on Systematic Planning Using the Data Quality Objectives Process (EPA QA/G-4). It would be useful to explain the interactions between the DQOs and Measurement Quality Objectives (MQOs). And it would be helpful to provide examples of DQOs in order to make them more “real” and to establish their value in project planning.

Section 2.5, Meteorological Monitoring: “*Other optional meteorological parameters such as solar radiation, precipitation and temperature may be measured.*” The OTM 30 report should make it clear that the on-site collection needs will vary depending on the dispersion model, and dispersion modeling

parameters, chosen. On-site collection of temperature, delta T, and solar radiation data are preferable to data from a more distant National Weather Service station.

Section 4.1, Unmonitored Sources of PM: *"Since the accuracy of K-factors in Equation 2 relies on good model predictions that correlate with PM monitor concentrations at the downwind site, it is important that all PM sources that contribute to downwind monitor concentrations are included in the dispersion model."* This is a key assumption of the OTM 30 method. With each new application of the method, the user must demonstrate that nearby dust source emissions are negligibly small compared to the area of interest, or sufficiently monitored so that the outside area contributions can be accounted for in the model. The text should be modified to make it clear that this is a deliberate and necessary step in the OTM 30 process.

Section 4.1, Unmonitored Sources of PM: *"(e.g. less than 20% of the total ambient PM impact)..."* The report should state the technical basis for choosing a criterion of 20 percent. If concentrations are within 20 percent of the PM₁₀ standard, then off-lake contributions can be important. For example, although the Owens Lake Dust ID model has been shown to work reasonably well when PM₁₀ concentrations are high, the uncertainty of the model increases considerably as the air quality standard is approached. Figure 11 in OTM 30 illustrates this observation, with the data scatter increasing considerably below a PM₁₀ threshold of roughly 600 micrograms per cubic meter ($\mu\text{g}/\text{m}^3$).

Section 6.3, PM Monitors: Section 6.3 does not provide a *distance criterion* to guide the placement of monitors upwind and downwind of a fugitive dust source. As shown on Owens Lake, the greater the separation distance between the monitors (both upwind and downwind) and the emissive area of interest, the greater is the uncertainty due to a variety of factors, including: differences in modeled vs. predicted plume dispersion, modeled vs. predicted wind fields, and "contamination" from nearby, unaccounted source areas. Higher uncertainty typically manifests itself as poor model performance. Guidance on the spacing of monitors away from the emissive area of interest is a critical element of any upwind-downwind monitoring program and must be included in the OTM 30 report.

Section 6.3, PM Monitors: *"In cases where downwind concentrations are very high relative to background concentrations and there are no other significant PM sources that contribute to the study area, the upwind background monitor does not necessarily have to be near the study area."* See the response to the comment immediately preceding this one. In addition to minimizing the importance of placing air quality monitors immediately around the area of interest, the statements are too vague and subject to individual interpretation. What defines "very high"? What defines "background"? What about "significant PM sources"? Owens Lake data show that upwind sources can be very far upwind and still have a major impact on a monitor. In addition, "background" concentrations can be highly variable and in the same concentration range as those originating from the source area(s) of interest. This is also the case for the Mono Lake data set. This section should be revised to offer clear, concise guidance for users.

Section 7.1, Preliminary Determinations: *"The number of monitoring sites should be tailored to the resources available for the project. More measurements will improve the accuracy of the results, but good emission estimates can still be derived from networks with fewer sand flux monitoring sites. The accuracy of the emission estimate primarily relies on the downwind monitor."* The text incorrectly suggests that the availability of resources (money) is the driver for determining the number of monitoring sites. The number of monitoring sites should be driven by the required accuracy of the data, and will vary with the size of the study area, the spatial variability in emission rates within the study area, and the complexity of dust sources around the study area.

Furthermore, the statement that *"the accuracy of the emission estimate primarily relies on the downwind monitor"* is incorrect. The accuracy of emission estimates derived from this method depend on many factors, including: (1) the representativeness of the monitoring network, (2) the accuracy of the estimated emissive area(s), (3) the correctness of the modeled wind fields and dispersion characteristics for individual wind events, (4) whether a dust plume actually crosses the PM₁₀ monitor, and many other factors.

Section 7.1.2, PM Monitor Locations: *"If there is a lack of significant dust sources impacting the upwind side of the study area, and the downwind PM concentration is expected to be much higher than the upwind concentration, the upwind monitor concentration can be represented by a regional background concentration."*

It is not acceptable to assume that background concentrations are insignificant and represented by the regional background concentration. An upwind monitor is always required to understand what part of the downwind concentration is caused by site emissions, and what part is coming in from upwind sources. Data from the Mono Lake study have shown that the "background" concentrations can vary by more than two orders of magnitude.

Also note that the performance evaluation in the OTM 30 report was conducted using a Mono Lake data set with *no upwind monitor*. This is a violation of the intent (if not the actual words) of the OTM 30 methodology, and makes clear the need for more, and more detailed, user guidance regarding the rationale for, and placement of, the upwind and downwind monitors.

Issue 4: OTM 30 Lacks a Concise Set of Data Screening Criteria

The OTM 30 report lacks a comprehensive set of data screening criteria, which are required to ensure a high quality data set for analysis. Moreover, the discussion of data screening is currently scattered throughout the document. The individual criteria should be gathered together in one section of the report.

Comments on individual areas are presented as follows.

Section 1.4, Measurement Quality Objectives (MQOs): This section in the OTM 30 report discusses Appendix C, which contains the MQOs for sand flux monitoring. This appendix presents separate MQOs for CSCs and Sensits. However, the premise of OTM 30 is that the CSC mass is linearly related to the total Sensit signal (measured either as kinetic energy, KE, or particle count, PC). Data collected at Owens Lake have shown that at low sand masses, the relationship between the Sensit response and the CSC mass ceases to exist, greatly increasing the uncertainty of the calculated hourly sand fluxes. Boundary conditions addressing this low-range uncertainty need to be added to the sand flux monitoring MQOs in Appendix C.

Section 2.3.2, Sensits: The text states that: "*Sensit readings are proportional to the mass flux of particles.*" This is not always true. Data collected on Owens Lake have shown that, in many instances, the relationship between these parameters ceases to exist at low rates of sand motion, which greatly increases the uncertainty of the calculated hourly sand flux values. Because of this low-range uncertainty, boundary conditions need to be added to the text and sand flux monitoring MQOs in Appendix C.

Section 2.7, K-factors: "*Because the edge of a dust plume has a very high concentration gradient, a few degrees difference in the plume direction could greatly affect a calculated K-factor.*" While we fully support this statement, the OTM 30 report does not include a screening criterion to correct for plume edge effects. LADWP has tried on many occasions to convince the Great Basin to implement this type of plume-profile screening in their Dust ID modeling for Owens Lake, but all requests have been denied on the grounds that the TEOM location within the modeled dust plume was *not a source of variability* in the computed hourly K-factors, despite abundant evidence to the contrary.

Note: The statement quoted above represents a significant departure from the way that the Great Basin conducts its Dust ID modeling on Owens Lake. If this statement is true (and we believe that it is), then why doesn't the Dust ID model contain screening criteria to account for plume edge effects?

Section 2.7, K-factors: "*These screening criteria may be modified by the user to ensure that enough hourly K-factors pass the screening criteria to yield reasonable results. For instance, in areas that have less wind erosion activity the screening criteria might be lowered [such that] hourly modeled and monitored PM_{10} are both greater than $50 \mu\text{g}/\text{m}^3$, and sand flux is greater than $0.1 \text{ g}/\text{cm}^2\text{-hr}$ in at least one sand flux site. This will allow more data to be used to calculate hourly K-factors.*" This paragraph should be removed in its entirety on the grounds that it directly contradicts the objectives of data screening, which is to ensure a high-quality data set for later analysis; specifically, a data set that represents hours when there is a strong relationship between sand flux (source) and PM_{10} concentration (receptor)—see the following discussion on Section 4.3. If there are too few data points that pass the screen, then the conclusion should be that there is an insufficient number of data points for calculation purposes, not that the screens should be relaxed. More specifically, if $50 \mu\text{g}/\text{m}^3$ and $0.1 \text{ g}/\text{cm}^2\text{-hr}$ are below the source-receptor range (see, for example, Figure 8 in OTM 30), then there is no meaningful relationship between

sand flux and PM concentrations. Lowering the screening criteria only adds meaningless, noisy data with significant uncertainty.

The text recommends that the user “adjust” (that is, lower) the screening criteria until there are “reasonable” results. What are “reasonable results”? This term is highly subjective and should be replaced with a criterion that can be measured, similar to the MQOs in the appendices. This criterion should reflect conditions where a strong source-receptor relationship can be assured.

Section 4.3, Weak Source-Receptor Relationships: “Because some areas may have smaller source areas or lower PM concentrations, overly restrictive screening could result in no usable results.” The objective of data collection is not to produce “usable results”; rather, the objective is to produce high-quality data that can be used to make decisions. Elsewhere in the report (Section 10, Step 2, pg. 19), OTM 30 suggests that the screening criteria should be “tailored” so as “to ensure that a reasonable number of hours [i.e., K-factors] pass the screens.” This recommendation is flawed and should be removed from the method. The screens are (correctly so) intended to “focus the hourly K-factors on the values that have the strongest source-receptor relationship” (Section 4.3 in OTM 30). At low sand mass and PM₁₀ concentration, the source-receptor relationship ceases to exist (for example, see Figure 8 in OTM 30). Any K-factors calculated in the absence of such a relationship are essentially random noise.

Section 8.1.3, Quality Control: This section reviews a number of quality control checks, including the need to “Check for anomalous data, such as non-zero Sensit readings during periods with low wind speeds that may be caused by something other than wind erosion.” It would be helpful if more clarification on these other reasons can be provided, as these are the reasons that the relationship between Sensits and CSC mass tends to weaken or disappear altogether at low sand activity levels.

Section 10.5, Calculate K-factors: Step 2 of this process (page 19 of OTM 30 report) is internally inconsistent. On the one hand, the text directs the reader to focus on the hours with strong source-receptor relationships. But later, the text directs the reader to relax the screens sufficiently to “ensure that a reasonable number of hours pass the screens.” These instructions are contradictory: the lower the screening thresholds, the lower the likelihood that a strong source-receptor relationship will be maintained in the data set. The OTM 30 methodology as currently described does not acknowledge that if the screening thresholds are set too low, the number of hours passing the screens may be reasonable (whatever “reasonable” means) but there may be no meaningful source-receptor relationship. The purpose of the screens is to ensure that a strong source-receptor relationship exists (see Section 4.3 of OTM 30 report, page 7, first paragraph).

This portion of the report should be rewritten to emphasize that the method should be on assuring the presence of a strong source-receptor relationship, as this underpins the scientific integrity of the method. Any K-factor developed when no source-receptor relationship is present represents random noise only, and has nothing to do with surface conditions or the emission factors thereof.

Issue 5: OTM 30 Relies on “Back Calculation” to Calculate Emission Rates

The emission rates in OTM 30 are back-calculated (that is, self-calibrated) by comparing the predicted hourly PM₁₀ concentration to the hourly PM₁₀ concentration difference observed between an upwind and downwind monitor. This practice of *self-calibration* contravenes long-established EPA modeling principles and guidelines.

The emission rates in OTM 30 are computed directly from *K-factors*, which are constants of proportionality, or more precisely, the ratio of the predicted (i.e., modeled) hourly PM₁₀ concentrations and the observed PM₁₀ concentration difference between upwind and downwind monitors. This is explained in OTM 30, Section 2.7, *K-factors* (emphasis added):

“The dispersion model is used to calculate K_t using PM emissions from Equation 1 assuming an initial K -factor, $K_i = 5 \times 10^{-5}$, which has been determined to be a good initial K -factor value that typically range from 1×10^{-5} to 10×10^{-5} for loose sandy soils.¹ Hourly K -factor values are then refined in a post-processing step to determine the K -factor value that would have made the hourly modeled concentration, C_m , match the observed hourly concentration, C_o , minus background, C_b , using Equation 2...”

Section 2.8, PM emission determination, continues:

“The final step in the test method is to calculate seasonal K -factors using the screened hourly K -factors. These K -factors are based on the geometric mean hourly K -factor for a user-defined period or season. The geometric mean is appropriate for this purpose because the hourly K -factors tend to follow a log-normal distribution curve. Seasonal K -factors are used with Equation 1 to estimate hourly PM emissions.”

The method description makes it clear that the PM₁₀ emission rates are simply a log-normal smoothing of the back-calculated (that is, self-calibrated) hourly *K-factors*. This practice of self-calibration is contrary to EPA principles and guidelines. The EPA's position is unequivocal (40 CFR Part 51, Revision to the Guideline on Air Quality Models: Adoption of a Preferred General Purpose [Flat and Complex Terrain] Dispersion Model and Other Revisions; Final Rule; November 9, 2005):

7.2.9 Calibration of Models

“Calibration of models is not common practice and is subject to much error and misunderstanding. There have been attempts by some to compare models estimates and measurements on an event-by-event basis and then to calibrate a model with results of that comparison. This approach is severely limited by uncertainties in both source and meteorological data and therefore it is difficult to precisely estimate the concentration at an exact location for a

specific increment of time. Such uncertainties make calibration of models of questionable benefit. Therefore, model calibration is unacceptable."

By recommending seasonal averages of hourly self-calibrated emission rates, OTM 30 is in direct conflict with the EPA standards that oppose model calibration.

Issue 6: The OTM 30 Model Performance Evaluation is Narrow in Scope and Biased

The performance evaluation in OTM 30 falls far short of what should be required for a new emission rate estimation method. Because this method is likely to receive highly varied and widespread use, a much more comprehensive and detailed performance evaluation is necessary. In addition, the performance evaluation should be extended to include only the Owens Lake data set. Although the Mono Lake performance results appear good, the period of evaluation is too short and the location lacks an upwind monitor to account for the incoming PM mass. For this reason, the Mono Lake data are not suitable for evaluating OTM 30 and should be removed.

Appendix A contains the Dust ID model performance evaluation that was submitted to the Great Basin by LADWP as part of the 2011 Alternative Analysis. This performance evaluation was based on Owens Lake data collected over the period from July 2006 through June 2010. Application of the OTM 30 methodology to this set of Owens Lake data would likely produce similar performance results because (as was explained earlier) there is relatively little difference between the Dust ID model and the OTM 30 methodology.

Section 12.0, Sample Application: The interpretation of Figure 8 as described in the OTM 30 text is statistically not defensible. In the OTM 30 report, a linear regression is performed on the curve using the entire Mono Lake data set, without (it appears) correcting for the approximately log-normal distribution of the data; hence the high R^2 value. Furthermore, visual inspection of Figure 8 shows that below a sand flux of about 20 grams per square centimeter per hour, there is no relationship between the daily average sand flux and the daily average PM_{10} concentration.

Section 12.0, Sample Application: *"The Mono Lake portable wind tunnel PM_{10} emissions algorithm that was originally used to model PM_{10} at Mono Lake underestimated monitored impacts for large events at this site by about a factor of 7."* The discussion of Figure 10 needs to be expanded: Were the wind tunnel and model runs performed at the same time? What were the regression statistics for the wind tunnel data? What does the line represent? Is this a fair comparison?

Section 12.0: (Figure 11), Sample Application: The linear regression statistics cited in the text regarding Figure 11 paint an overly optimistic picture of the relationship between the observed and predicted PM_{10} concentrations. First, the regression analysis was incorrectly performed using non-log transformed data

(as a result, the data are not normally distributed), with the line fit through the origin. As a result, the R^2 values are higher than they would have been using log-transformed data and where the line is not forced through the origin. Second, the authors fail to acknowledge that model predictions and observations appear to be well correlated only in the high concentration range. Below about $600 \mu\text{g}/\text{m}^3$ (both predicted and observed), model performance drops significantly with differences of up to two orders of magnitude between the predicted and observed values.

Section 12.0, Figure 12, Sample Application: The claim is made that the PM_{10} concentrations tracked "favorably" over "a 4-order of magnitude concentration range." While this statement appears to be true based on Figure 12, it is misleading and does not reflect the overall performance of the method. K-factors were developed for only two-thirds of the hours on the event day displayed in Figure 12. Thus, since this event was heavily calibrated it should be no surprise that the model and observed concentration track well. However, this is a coincidence, and not the norm for the model performance, and it does not represent the majority of hours that were not included in the K-factor calculations.

Following are some additional comments regarding the performance evaluation presented in OTM 30:

- The performance evaluation in OTM 30 is misleading because it compares the self-calibrated PM_{10} concentrations with the observed PM_{10} concentrations. The problems are two-fold: (1) there is no independent measure of the accuracy of the OTM 30 emission rates, and (2) using the observed and predicted concentrations as an indirect means of evaluation is of limited value because the two parameters are *not independent*; the latter was calibrated to the former.
- The performance results in OTM 30, at least the high arithmetic R^2 values, are driven by the highest concentrations. However, data from Owens Lake show that the method performs poorly at low concentrations, particularly if the spacing between the monitors is great, or if the monitors are not well centered on the dust plumes leaving the emissive areas. Most fugitive dust sites causing non-attainment in the western United States are characterized by relatively low PM_{10} concentrations. This greatly limits the range of use of OTM 30. Guidelines must be established to limit the use of this method to high concentrations only, unless the EPA presents data showing that the method performs acceptably well at medium to low concentrations.
- The performance evaluation in OTM 30 uses data from Mono Lake, California, but, significantly, the monitoring network at Mono Lake **does not include an upwind monitor**. It is not acceptable to simply assume that the incoming concentrations are at or near regional background levels, as this particular case study assumes. Without upwind monitoring data, the performance evaluation is unusable because it ignores a common source of uncertainty: variable upwind PM_{10} concentrations.

The deficiencies noted above and in the enclosure should be addressed before EPA considers reposting OTM 30. In addition, LADWP strongly recommends that the EPA conduct its own third-party review of

OTM 30 to ensure that the proper levels of validation and documentation are provided, including discussions pertaining to recommended applications and limitations of the method. We appreciate the opportunity to provide these comments to EPA. If you have any questions or would like to discuss these issues, please contact me at (213) 367-1014 or Mr. William T. Van Wagoner at (213) 367-1138.

Sincerely,



Martin L. Adams
Director of Water Operations

WTV:jm

[Sent via Federal Express and Email (Oldham.conniesue@epa.gov.)]

Enclosure

- c: Mr. Dennis Mikel, EPA (via email only)
- Mr. Larry Biland, EPA (via email only)
- Ms. Nancy Marvel, EPA (via email only)
- Mr. Allan Zabel, EPA (via email only)
- Mr. William Van Wagoner, LADWP

APPENDIX A

Dust ID Model Performance on Owens Lake

**(Excerpt from LADWP Response to Great Basin's 2011 Supplemental
Control Requirement Determination)**

Summary of Dust ID model performance on Owens Lake, 2006-2010

Background

This document provides a summary of the performance of the Great Basin Unified Air Pollution Control District's (District) Dust Identification (Dust ID) program implemented on the Owens Lake playa. The monitoring and modeling methodology applied in the Dust ID program is nearly identical to the methods recently proposed in Other Technical Method (OTM) 30. The performance review of the application of the Dust ID program provides insights into the performance of the OTM 30 methodology in a more complex setting, compared to the Mono Lake site, used as the example in the OTM 30 document. The Mono Lake study is somewhat ideal, as the site is characterized by: 1) a dense monitoring system (25 sand flux monitors per square km, about 1 per 20 acres), 2), a relatively uniform surface (sandy beach), 3) the PM₁₀ monitor right on the boundary of the study area, and, 4) relatively low background PM₁₀ contributions from areas surrounding the site. In comparison, the Owens Lake site is characterized by: 1) a more sparse monitoring system (sand flux sites representing areas from 8 to over 300 acres, 70 acres on average), 2), considerable spatial variation in soil type and surfaces, and temporal variation in PM₁₀ emissions, 3) distances between source areas and PM₁₀ monitors vary from the edge of the source area (the exception) to a one to five mile range (more typical), and, 4) background PM₁₀ contributions from areas surrounding the lake bed in a similar concentration range as those from the lakebed. Thus, the Owens Lake data set provides important insights into the performance of this methodology in a more complex situation. These performance evaluation results are important to consider in applications of OTM 30 in areas other than Mono Lake.

Performance Measures

The complete model performance of the Dust ID program on Owens Lake over four dust season, specifically, July 2006 through June 2010, is summarized in the next section. The full performance analysis, part of this attachment, is based on Section 5 ("*Dust ID Model Performance and Implications*") of the response of the Los Angeles Department of Water and Power (LADWP)¹ to the District's 2011 Supplemental Control Requirement Determination.² This model performance evaluation focuses on three performance measures, which were mutually agreed upon by the District and LADWP in July 2008. These three performance measures are:

- Quantile-Quantile (Q-Q) Plots - Qualitative (visual) measure of model performance using plots of observed versus predicted shoreline PM₁₀ concentrations that have been paired by concentration rank: highest predicted with highest observed, 2nd highest predicted with 2nd highest observed, and so on. Method decouples observations and predictions in space and time.

¹ Air Sciences Inc., 2011. *Response to the Great Basin Unified Air Pollution Control District's Preliminary Supplemental Control Requirements Determination for 2006-2010*. Prepared for Los Angeles Department of Water and Power, June 3, 2011.

² Great Basin Unified Air Pollution Control District, 2011. *Owens Lake Dust Control Preliminary 2011 Supplemental Control Requirements Determination, Air Pollution Control Officer's Preliminary 2006 through 2010 Determination Requiring the City of Los Angeles to Implement, Operate and Maintain Air Pollution Control Measures on Additional Areas of the Owens Lake Bed (Preliminary SCR Determination)*, dated April 7, 2011.

- Scatter plot with linear regression – Strengths of the regressed line is evaluated as the coefficient of Determination (R^2), which provide a measure of the degree of scatter in the relationship between the observed and predicted shoreline PM_{10} concentrations. Method maintains pairing of observations and predictions in space and time.
- Fractional Bias – Implemented on a paired in space and time basis. Provides a measure of average relative error (difference between observed and predicted values normalized to their sum) from a box plot by PM_{10} concentration range.

Performance Results

The results of the over the 2006-2010 period indicated that the Dust ID model performed poorly by two of the three statistical measures mutually agreed to by the District and LADWP. The model performed reasonably well based on the unpaired QQ plots, which do not consider time and space elements fundamental to calculating emission rates on the Owens playa. The calculation of emission rates is also an essential element of the methodology described in OTM 30 (for example, Section 10.0, Figure 9). The more appropriate and relevant measures based on paired showed that the model generally performed poorly. Model predictive capability was zero to very low, with R^2 -values ranging from 0 to 0.58 (overall 0.11). Examination of the paired fractional bias plots indicates that the Dust ID model tended systematically over-predicted observed PM_{10} concentrations.

SECTION 5: DUST ID MODEL PERFORMANCE EVALUATION AND IMPLICATIONS

This section evaluates the statistical performance of the Dust ID model over the period of the Preliminary SCR Determination from July 2006 through June 2010. The goal of the performance evaluation is to assess the capability of the Dust ID model to predict PM₁₀ concentrations. This is done by comparing the modeled (predicted) PM₁₀ concentrations and observed (known) PM₁₀ concentrations at nine monitoring sites operated by the District around the perimeter of Owens Lake. While not required for SCR Determinations according to the 2008 SIP (District 2008a), this performance evaluation is nonetheless important because the Dust ID model is used to identify the supplemental control areas and the required control efficiencies. To ensure timely and cost-efficient progress toward the goals of the 2008 SIP, the Dust ID model must be reasonably correct.

The results of this performance evaluation show that the Dust ID model performs poorly by nearly all measures. The results contained herein should further inform the District about the need for additional, immediate, and substantial improvements to the Dust ID model. The Dust ID model should not be used for this or any future SCR Determination until the model has been sufficiently refined and independently verified to perform within the range of scientific acceptability.

5.1 Methods of Evaluation

LADWP's model performance evaluation was performed in three steps:

1. Identify the appropriate data set(s)
2. Screen the data to ensure quality, consistency, and relevance
3. Calculate statistical measures of performance

Each of these steps is further described in the sections that follow. The model results, discussion, and conclusions are presented in Sections 5.2 through 5.4, respectively.

5.1.1 Evaluation Data Set

The model performance evaluation is based on a set of observed and predicted 24-hour average PM₁₀ concentrations obtained from the District. This is the same averaging period used to evaluate the NAAQS for PM₁₀ on Owens Lake. The predicted PM₁₀ concentrations are from the same model runs used to evaluate the accuracy of the District's Dust ID modeling analysis in Section 3 of this document. This evaluation, however, combines the one-hour data (from July 2006 through February 2009, 32 months) and five-minute data (from March 2009 through June 2010, 16 months) into a single set of composite one-hour values. The observed PM₁₀ concentrations were

obtained from the District for the same period as the Dust ID modeling analysis used in the Preliminary SCR Determination.

5.1.2 PM₁₀ Filtering Criteria

Prior to performing the statistical tests, the PM₁₀ concentration data were screened to focus the model performance evaluation on the most relevant PM₁₀ concentration range, locations, time periods, and wind directions. LADWP augmented the PM₁₀ filtering criteria from the 2008 SIP (District 2001, 2003) in order to provide a more refined model performance evaluation.

Table 5-1 contains the default 2008 SIP screens as well as the more refined Alternative Analysis screens. The first three screens are consistent with those provided in the 2003 SIP and with the District's evaluation of the five-minute modeling data included in the Preliminary SCR Determination. The four additional screening criteria shown are refinements designed to improve the representativeness of the data set. These additional criteria have not been defined in the mutual agreement on model performance evaluation procedures between LADWP and the District (District 2008b), as that agreement was more general in nature.

5.1.3 Model Performance Measures

The EPA has published general guidelines on evaluating model performance of air quality models and for comparing the performance of different models or model scenarios (EPA 1992). However, in its earlier guidance (EPA 1984), EPA recommends that methods to evaluate specific (non-conventional) model applications be developed on a case-by-case basis, in mutual agreement between the applicant (LADWP) and the regulatory agency (District). In this context, the evaluation methodology applied in this analysis is based on a set of statistical measures mutually agreed upon by LADWP and the District during the Expert Panel process (District 2008b).

The District describes statistical methods that were used to compare several Dust ID model scenarios in an Appendix to the 2003 SIP (District 2003). This set of statistical measures was also adopted in the 2008 SIP (District 2008a). Since then, as part of the Expert Panel process, LADWP and the District have mutually agreed to narrow down model performance evaluations to three statistical measures (District 2008b). These measures consist of the following and are described in more detail below:

1. Scatter plots with regression analysis
2. Quantile-Quantile (Q-Q) plots
3. Fractional bias plots

The first and third measures base the model evaluation on paired data; specifically, a modeled concentration is compared with the (correct) observed concentration at the

Table 5-1. Summary of Screening Criteria Used in Model Performance Evaluation

Purpose of Screen	2008 SIP Filtering Criterion	Performance Evaluation Screen
Focus evaluation on days exceeding NAAQS only.	PM ₁₀ concentration screened as: geometric mean of observed and modeled concentrations greater than 150 µg m ⁻³ .	
Account for background PM ₁₀ that is not included in model.	Background of 20 µg m ⁻³ assumed. Added to all model concentrations.	Adopted same screen as 2003 SIP. Observed 24-hour background PM ₁₀ approximately 18 µg m ⁻³ .
Evaluate performance on overall basis as well as spatially explicit basis.	District performs evaluations based on all and individual PM ₁₀ monitoring sites.	
Evaluate data based on most relevant data period(s).	Data period over which evaluation to be executed not specified in 2003 SIP.	Evaluate performance over entire period (2006–2010) and for each dust season separately. SIP allows District to determine new control areas after each dust season. Thus, season is relevant basis of evaluation.
Evaluate most relevant PM ₁₀ monitoring sites.	District operates three types of monitoring sites: shoreline, community, and on-lake monitors.	Limit evaluation to shoreline and community monitors only, since this is where compliance with NAAQS is determined.
Screen data for off-lake wind directions.	District bases evaluations on all wind directions. No wind direction screen applied.	Limit evaluation to on-lake wind directions only. Except for Keeler Dunes, off-lake sources are not monitored and not accounted for in Dust ID model.
Define basis to evaluate model bias.	Bases (fractional) bias analysis on default geometric mean classification (see first screen above).	Base classification on model concentration only: In compliance determination only the model concentration is known. Observed PM ₁₀ concentrations are known only at nine shoreline and community sites.

same location (monitor) and for the same 24-hour period (calendar day). The second method—Q-Q plots—is based on unpaired data. This method evaluates how well the distribution of modeling results mimics the distribution of observed concentrations. However, it decouples the temporal and spatial association between modeled and observed concentrations (Section 5.1.3.2), which are essential for accurately calculating emission rates on the Owens playa using the Dust ID model.

Q-Q plots are part of the methodology applied to evaluate the EPA’s guideline AERMOD model (EPA 1998). But more recent performance evaluations of meteorological and dispersion models carried out for or by the EPA have been based on

paired measures only, including scatter plots, regression analysis, and fractional bias evaluations (EPA 2002; EPA 2005).

5.1.3.1 Scatter Plots with Regression Analysis

Scatter plots provide a visual tool to examine the relationship, or correlation, between two variables. In the case of a perfect linear correlation between two variables, all the (X,Y) data points fall on the same straight line. Examples of scatter plots with varying degrees of correlation are shown in the left half of Figure 5-1. Scatter plot scenarios 1 to 3 in Figure 5-1 show, in order: a strong correlation, an intermediate correlation, and an absence of correlation, respectively.

Because scatter plots are visual in nature only, they are often used in combination with regression analysis. Regression analysis provides a visual trend line for the data shown in a scatter plot, as well as quantitative statistics describing the nature and strength of the relationship between two variables. In linear regression, one (the dependent) variable is expressed as a linear function of another (the independent variable), based on the following general equation:

$$Y = \text{intercept} + \text{slope} * X$$

Equation 1

In the case of performance evaluations of the Dust ID model, the X and Y variables are the modeled and observed PM₁₀ concentrations (or vice versa).

The strength of the relationship between X and Y can be expressed as the correlation coefficient, or *R*. The correlation coefficient is a quantitative measure that indicates the strength of the relationship between two parameters. If two variables are perfectly positively correlated (Y increases as X increases), *R* takes the value of 1. If two variables are perfectly negatively correlated (Y decreases as X increases), *R* takes the value of -1. In the absence of a correlation between two variables, *R* takes the value of 0. An advantage of the use of *R* is that it indicates the direction, positive or negative, of the correlation between two variables.

A measure derived from *R* that is easier to interpret is the coefficient of determination, or *R*². Both the District and LADWP agreed to use this statistic to evaluate Dust ID model performance. The advantage of *R*² is its practical

A *scatter plot*, also called an x:y plot or scatter gram, is a qualitative, visual tool used to show patterns of correlation between two variables. Much can be learned about the strength of a relationship from scatter plots.

The *coefficient of determination*, or *R*², is a measure of the "goodness-of-fit," or predictive power, of a model. A perfect model has an *R*² of 1. A model without any predictive power has an *R*² of zero.

interpretation. Specifically, R^2 indicates the proportion of the variation in one variable (Y) that is explained by the variation of the other variable (X). For example, a perfect model explaining 100 percent of the variation would have an R^2 value of 1. A model with no predictive power would have an R^2 value of 0 (zero). R^2 values associated with the scatter plots in Figure 5-1 are printed in the upper-left corner.

An important aspect of scatter plots and regression analysis is that these only describe the statistical relationship between two variables. A reasonable basis of a causal relationship between two variables cannot be established based on these statistics alone; rather, it needs to be established based on a physical or logical relationship between two variables. In addition, a correct, justifiable regression analysis requires that several basic assumptions are met. One of these assumptions is that the underlying data follow an approximately normal distribution. Such a distribution is typically visualized as a data distribution following a more or less bell-shaped curve with symmetrical tails on either side of the peak. In the case of typical PM_{10} concentrations observed and modeled at Owens Lake, low and high concentrations can vary by up to four orders of magnitude (zero to almost 10,000). Since this extreme data range does not lend itself to achieving a normal distribution, PM_{10} concentration data are converted to logarithmic scale:

$$\text{Log}_{10}(X)=(Y) \quad (\text{for example, } \text{Log}_{10}(10)=1, \text{Log}_{10}(100)=2, \text{etc.}) \quad \text{Equation 2}$$

Based on this conversion, PM_{10} concentrations typically follow a normal distribution, and regression analysis can be performed correctly. Because of the required log transformation, the axes in the scatter and Q-Q plots in the rest of this section are always on \log_{10} -transformed scales.

FIGURE 5-1. EXAMPLE SCATTER PLOTS AND QUANTILE-QUANTILE PLOTS FOR DIFFERENT FICTITIOUS DATA SETS

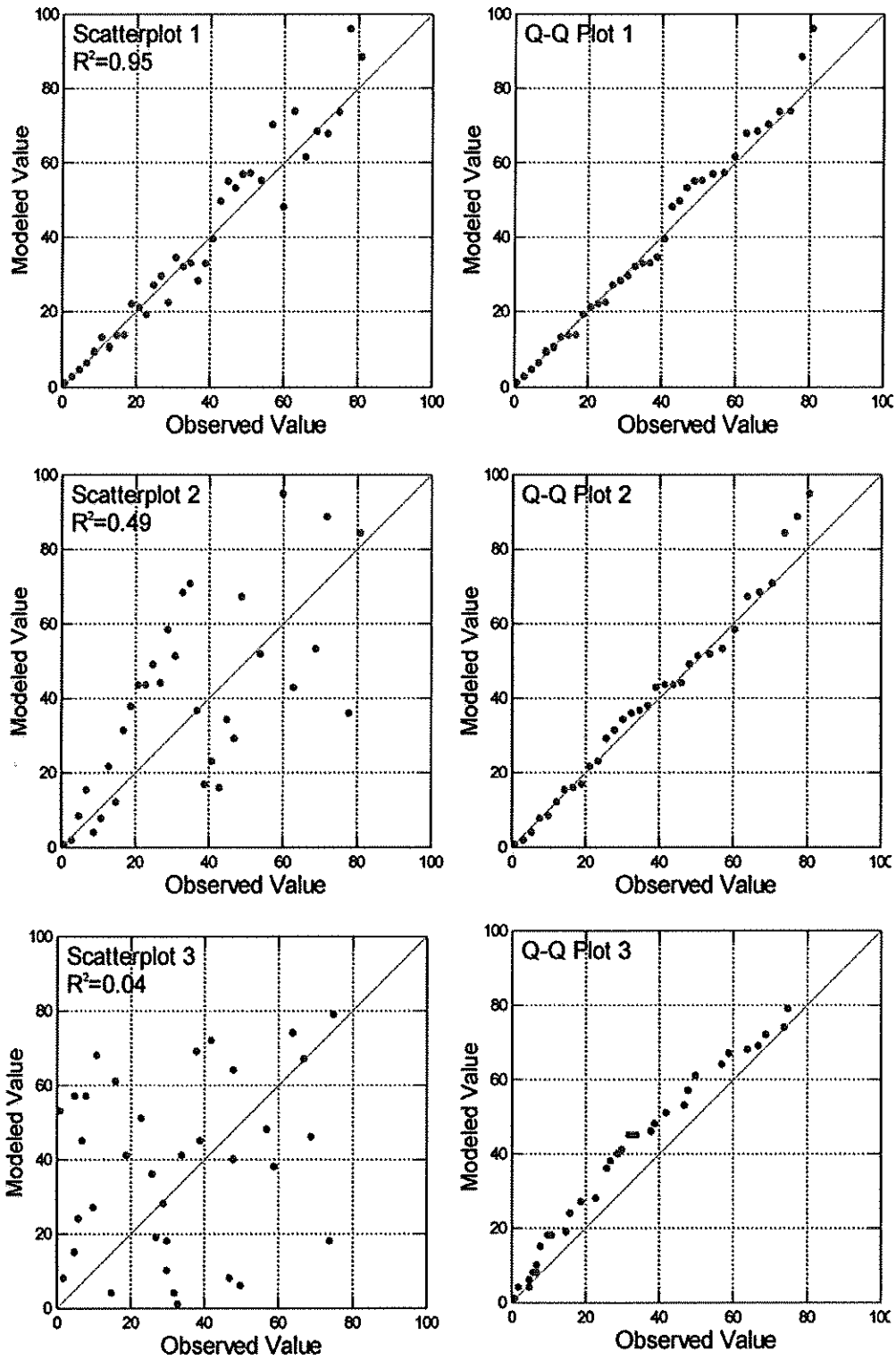

5.1.3.2 Quantile-Quantile Plots

Quantile-Quantile (Q-Q) plots provide a visual, qualitative means to evaluate the similarity of two data distributions. Each variable is ranked separately from highest to lowest, and values of similar rank are plotted together on a graph. For example, in the case of Dust ID model data, the maximum observed PM₁₀ concentration is plotted against the maximum modeled PM₁₀ concentration, the second-highest observed PM₁₀ concentration is plotted against the second-highest modeled PM₁₀ concentration, etc.

Q-Q plots can be useful in model evaluations if the primary interest is in determining how well the distribution of modeled concentrations matches the distribution of observed concentrations, especially when pairing in time and space is of lesser importance (for example, EPA 1998).

A major disadvantage of Q-Q plots is that important information about how well the modeled concentrations compare (in time and space) to the observed concentrations is lost in the ranking process. As a result, Q-Q plots only indicate the level of agreement between two data distributions. A "good" comparison is typically one in which the data points fall roughly along a straight line (preferably a 1:1 line; see diagonal gray lines in Figure 5-1). However, Q-Q plots can tell very little about how well the two variables compare on a paired basis; in fact, the comparison can be quite poor. To illustrate this point, the Q-Q plots on the right half of Figure 5-1 correspond with the scatter plots on the left half. In Figure 5-1, Q-Q Plot 1 corresponds with Scatter Plot 1 (which has the highest R^2 value, indicating a high correlation) and provides the best linear fit of the ranked data. However, Q-Q Plot 3 still shows a reasonable linear fit of the ranked data, even when the corresponding Scatter Plot 3 shows no relationship at all.

In the case of the Dust ID model results, a review of ranked model data shows that within each ranked data pair, the observed and modeled concentrations typically do not occur at the same location or even on the same day. Because the Dust ID model is calibrated through the calculation of K-factors in a space-and-time-dependent manner, Q-Q plots are of limited value in evaluating the overall performance of the Dust ID model. A more comprehensive evaluation of the Dust ID model's performance must include scatter plots and regression analysis (previous section), and fractional bias (next section).

Quantile-Quantile (Q-Q) plots are a simple means to see whether two variables have a similar data distribution (or spread of the data). The highest value of variable X is ranked with the highest value of variable Y, the second highest with the second highest, and so forth... This ranking process obscures any important time and space relationships that might exist in the data.

5.1.3.3 Fractional Bias Plots

Fractional bias (FB) is one of the performance measures proposed by the EPA to evaluate model performance (EPA 1992). It provides a measure of the general bias of a model. Bias refers to the tendency of a model to systematically over- or under-predict the actual values. The absence of bias provides evidence that the model is accurately predicting values. In its application to PM₁₀ concentrations along the Owens Lake shoreline, FB is defined as the difference between the observed and modeled values, normalized to their sum:

Fractional bias is a relative measure of a model's *bias*. Bias is defined as the systematic error in model predictions, positive or negative, compared to the true observed value.

$$FB = -2 * \frac{[Observed - Modeled]}{[Observed + Modeled]} \quad \text{Equation 3}$$

Values of FB vary from -2 to 2, indicating extreme under-prediction and extreme over-prediction, respectively. An FB value of 0 (zero) indicates that the observed and modeled values are identical. It should be noted that the LADWP and the District agreed to base the FB calculation on a paired basis, similar to the scatter plots and regression analysis (District 2008b). This differs from EPA guidance (EPA 1992), which bases FB on the highest unpaired values.

An example of FB for a fictitious data set is shown in Figure 5-2. Three scenarios are plotted in the scatter plot on the left. The box plot on the right indicates the difference between systematic over- and under-prediction (red and green circled groups on the X-axis, respectively) for these same scenarios. The lower, middle, and upper boundaries of the boxes in the box plot on the right represent the 25th, 50th, and 75th percentile values of the FB. These percentiles represent the fraction of the data points lying below that value; for example: 25 percent of the values in the data set are lower than the 25th percentile, 50 percent are lower than the 50th percentile, and so on. Note that Section 5.2 of this document presents similar box plots based on the actual Dust ID modeling data. Finally, the gray box indicates the region where the modeled value is within a factor of two of the observed value. This range is referred to in the EPA guidelines as an "acceptable" model performance range (EPA 1992). However, because the EPA guidelines are based on very different statistical methods, and are embedded in a different regulatory context, the factor-of-two range does not have any regulatory significance. It is included in the figures only to help differentiate the regions of extreme over- and under-prediction.

FIGURE 5-2. EXAMPLE OF SCATTER PLOT WITH CORRESPONDING FRACTIONAL BIAS BOX PLOT

The gray area on the fractional bias box plot indicates differences within a factor of two.

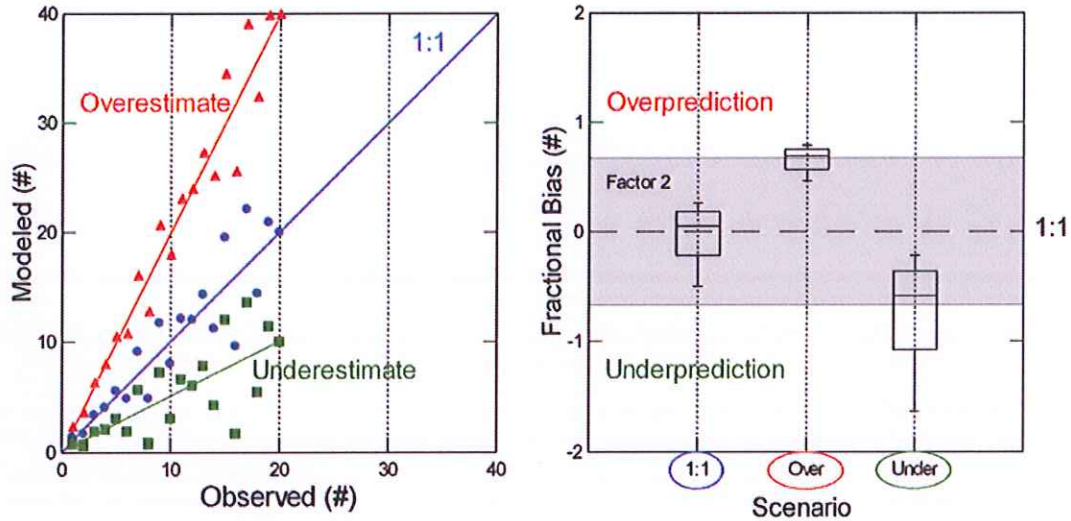

5.2 Results

5.2.1 Results by Entire Period

In the first assessment, the 24-hour PM_{10} concentrations measured over four dust seasons (July 2006 through June 2010) were grouped into a single data set. The summary plots for this assessment are shown in Figure 5-3. Although there is significant variability between the observed and modeled concentrations in the scatter plot (Figure 5-3, top left), the Q-Q plot indicates that all ranked data pairs fall well within a factor of two, and mostly on a straight line (Figure 5-3, top-right). Thus, according to the Q-Q plot's representation of the full data set, the observed and modeled PM_{10} concentrations have a similar distribution. However, as pointed out earlier, for the majority of data pairs, the observed and modeled concentrations occurred on different days within the four-year period, at different locations (at any of the nine included monitors), or both. This limits the usefulness of the Q-Q plots in evaluating the performance of the Dust ID model, as the model is calibrated and implemented in a space- and time-specific manner.

The scatter plot in Figure 5-3 shows that there is significant variability in the performance of the Dust ID model when the data points are paired in space and time. The degree of scatter varies with the concentration range. The scatter in the observed concentrations is generally high when the modeled concentration is low, and low when the modeled concentration is high. Overall, the model does a poor job at simulating the observed concentrations.

The regression analysis for this data set shows that only 11 percent of the variation in the observed concentrations is explained by the modeled concentrations ($R^2=0.11$). In other words, the Dust ID model does not account for 90 percent of the variability in the observed PM_{10} concentrations. This lack of predictive capability is attributable to a combination of random variability (system noise), uncertainties in the input variables, and many other factors.

Figure 5-4 provides another way to look at the variability in the modeled PM_{10} concentrations. This figure illustrates the same data set as Figure 5-3, but it divides the box plot into four areas or quadrants. The top-right quadrant, I, contains data pairs in which both the observed and modeled concentrations are above the NAAQS for PM_{10} (that is, concentrations are $>150 \mu\text{g m}^{-3}$). Even though both concentrations in quadrant I exceed the NAAQS, the observed and modeled concentrations may still differ by a factor of 10 or more. In the top-left quadrant, II, the observed concentrations exceed the NAAQS but the modeled concentrations do not. Points lying in quadrant II can be attributed to missed or mischaracterized on-lake dust sources, or, alternatively, to off-lake dust sources that are not accounted for in the model. In the lower-right quadrant, IV, the modeled concentrations exceed the NAAQS but the observed concentrations do not. Points lying in quadrant IV are considered in error, which can be caused by many factors, including mismatches between the actual and modeled plume trajectories, mismatches between the cross-wind plume profiles, or other factors that lead to a general tendency to over-predict.

Finally, the fractional bias summary of the entire data period (Figure 5-3, lower-left panel) indicates that the Dust ID model tends to over-predict, with the typical (median) over-prediction around a factor of two. The degree of over-prediction decreases in the highest concentrations class, which is consistent with the trend shown in the scatter plot.

Only 11 percent of the variation in the observed PM_{10} concentrations is explained by the modeled PM_{10} concentrations ($R^2=0.11$). This means that 89 percent of the variation is not accounted for by the Dust ID model.

FIGURE 5-3. SCATTER AND Q-Q PLOTS FOR COMBINED DATA PERIOD

For reference, the following lines are added: NAAQS (orange lines), 1:1 line indicating a perfect prediction (diagonal gray line in X:Y Plot), and a factor of two around the 1:1 line (diagonal gray lines in Q-Q plot).

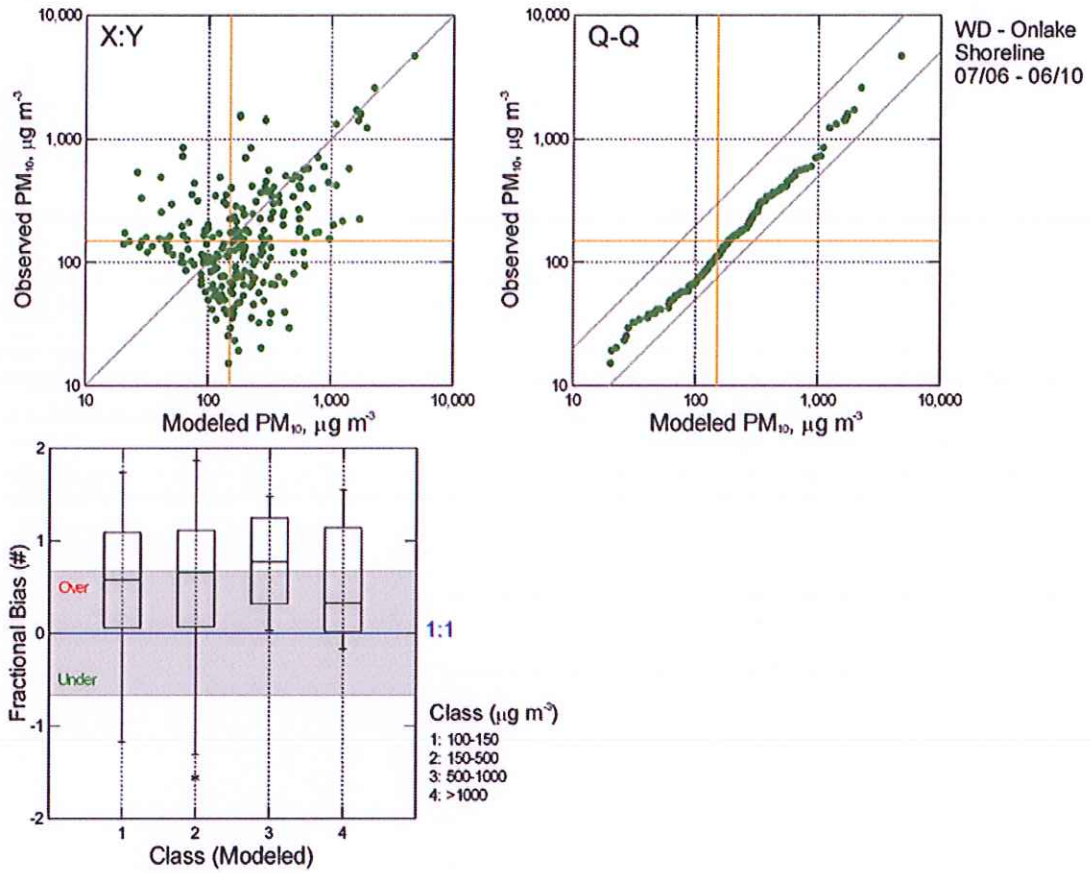
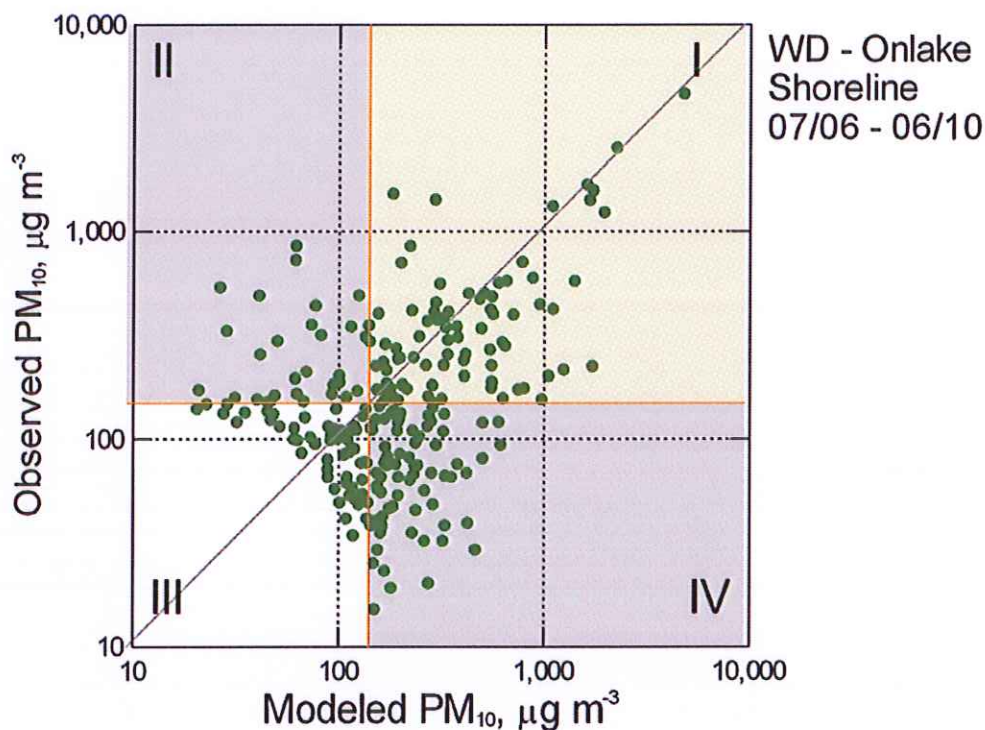

FIGURE 5-4. SCATTER FOR COMBINED DATA PERIOD OVERLAID WITH QUADRANTS

Quadrants are indicated by roman numerals.



5.2.2 Results by Dust Season

This section summarizes model performance results on a per-dust-season basis. A dust season is defined as the period from July 1 of each year through June 30 the following year (District 2008a). This period is a relevant basis of model performance because the 2008 SIP specifies that the District evaluate PM_{10} exceedances and source areas requiring mitigation measures based on an annual-dust-season basis (District 2008a, Section 8). Moreover, each year the Dust ID model essentially is recalibrated in that a new, dust-season-appropriate set of K-factors is developed (see Section 4).

5.2.2.1 Scatter Plots with Regression Analysis

Figure 5-5 shows the scatter plots of the Dust ID model performance of each of the four dust seasons over the period from July 2006 to June 2010. Similar to the analysis over all dust seasons (previous section), there is significant scatter in the data, especially during the 2006 to 2009 dust seasons. The visual absence of a relationship between the modeled and observed concentrations for three out of four dust seasons (Figure 5-5) is confirmed by the results of the regression analysis (Table 5-2). Only the R^2 value for the 2009–2010 dust season is strongly, significantly different from zero (indicated by the far column, “model significant”), with the model explaining 42 percent of the variation in the data.

However, for the other seasons, the model explains five percent or less of the variation in the data (R^2 values from 0 to 0.05; Table 5-2). On a practical level this means that the regression lines over the first three dust seasons cannot be distinguished from random chance. The model for these seasons thus provides no evidence for an actual physical relationship between observed and modeled concentrations. In this case, in the absence of a statistically significant model, regression lines with similar R^2 values could have been achieved by plotting two completely unrelated, random data sets against each other.

In addition, with the exception of the 2009–2010 season, the regression indicates that all models have significant bias (Table 5-2). Bias measures the deviation from the average model concentration from the average, correct, observed concentration, and can indicate a general tendency of the model to either over- or under-predict. Visually, bias is indicated as the intercept with the Y-axis, or the point where the regression line crosses the observed axis. In a non-biased system, this intercept is near corresponding model value (in the case of Figure 5-5, the lower-left point (10,10)).

Finally, the stronger relationship observed over the 2009–2010 season is heavily influenced by a few high concentration days that occurred at the Lizard Tail location. Removing the four highest PM_{10} concentration pairs (those over $1,000 \mu g m^{-3}$) at Lizard Tail from the 2009–2010 data set (out of $N=104$, so less than 4 percent of the data), reduced the R^2 value 0.42 from to 0.28. Likewise, when seven Lizard Tail data pairs from the 2008–2009 data (less than 10 percent of the 2008–2009 data) are removed from the data set, the regression model for that season is no longer statistically significant.

5.2.2.2 Quantile-Quantile Plots

The Q-Q plots based on each dust season are shown in Figure 5-6. Using the outer gray diagonal lines that indicate a factor-of-two deviation as a visual guide, the tendency of the model to over- or under-predict can be evaluated. Examination of the Q-Q plots indicates that in the 2006–2007 and 2007–2008 seasons, the ranked data compare reasonably well in the higher concentration range, but that the model tends to under-predict in the lower range (Figure 5-6). In the 2008–2009 season, the data pairs fall mostly within the factor of two over the entire concentration range. However, in the 2009–2010 season, the model tends to over-predict the observed values considerably (Figure 5-6), especially in the lowest concentration range where the ranked data pairs fall outside the factor of two.

5.2.2.3 Fractional Bias

The fractional bias results for each dust season tend to confirm the results based on the Q-Q plots discussed in the previous section (Figure 5-7). In the 2006–2007 dust season, the model under-predicts in the low concentration range, and over-predicts in the high range. The 2007–2008 and 2008–2009 seasons show a systematic over-prediction in all

concentration ranges, although this over-prediction is typically within a factor of two of the observed. Similar to the Q-Q plots, the fractional bias of the 2009–2010 season indicates that the model systematically over-predicts observed concentrations with the majority of the deviations falling well outside of a factor-of-two margin (Figure 5-7).

FIGURE 5-5. SCATTER BY DUST SEASON, ALL SHORELINE MONITORING SITES COMBINED

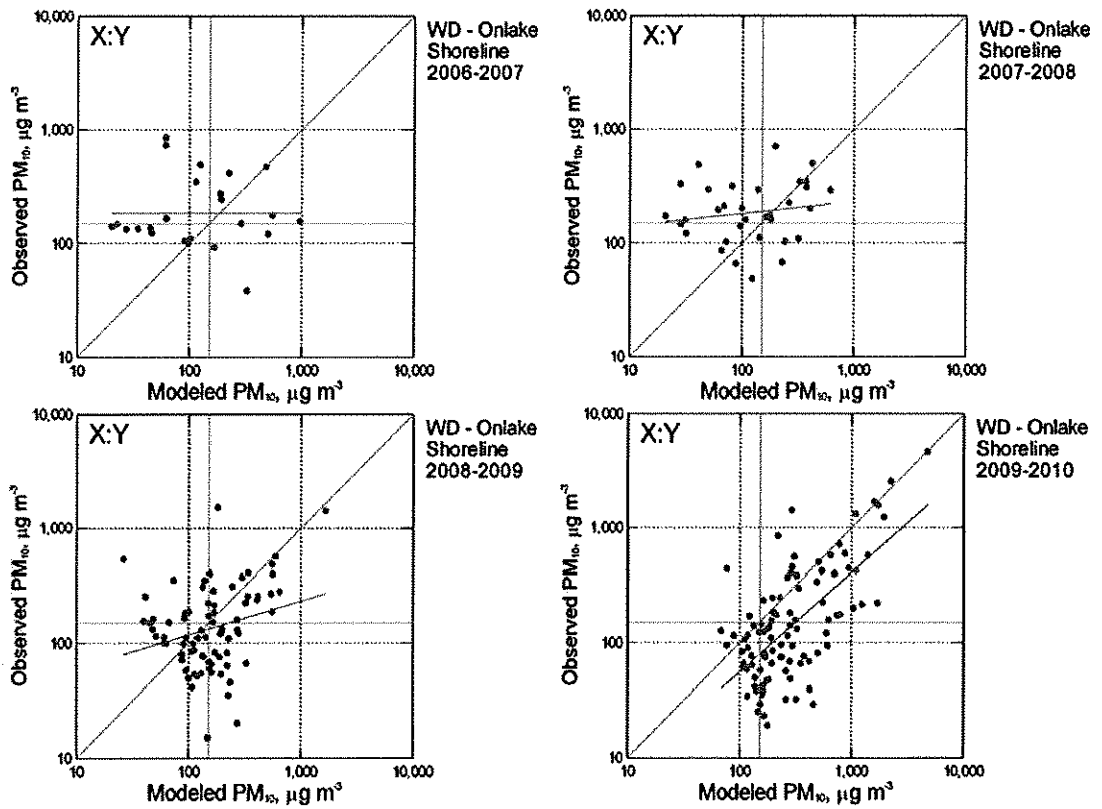

TABLE 5-2. REGRESSION SUMMARY BY DUST SEASON

Dust Season	Sample Size (N)	R ²	Significant Bias (p<0.05) ¹	Significant Model (p<0.05) ²
All	241	0.11	Yes	Yes
0607	24	0.00	Yes	No
0708	33	0.03	Yes	No
0809	80	0.05	Yes	Yes - Marginally
0910	104	0.42 ¹⁸	No	Yes

¹ Indicates a 95 percent confidence level that the bias (the intercept of regression line) is different from zero.

² Indicates a 95 percent confidence level that the model (the slope of the regression line) is different from zero.

FIGURE 5-6. Q-Q PLOTS BY DUST SEASON, ALL SHORELINE MONITORING SITES COMBINED

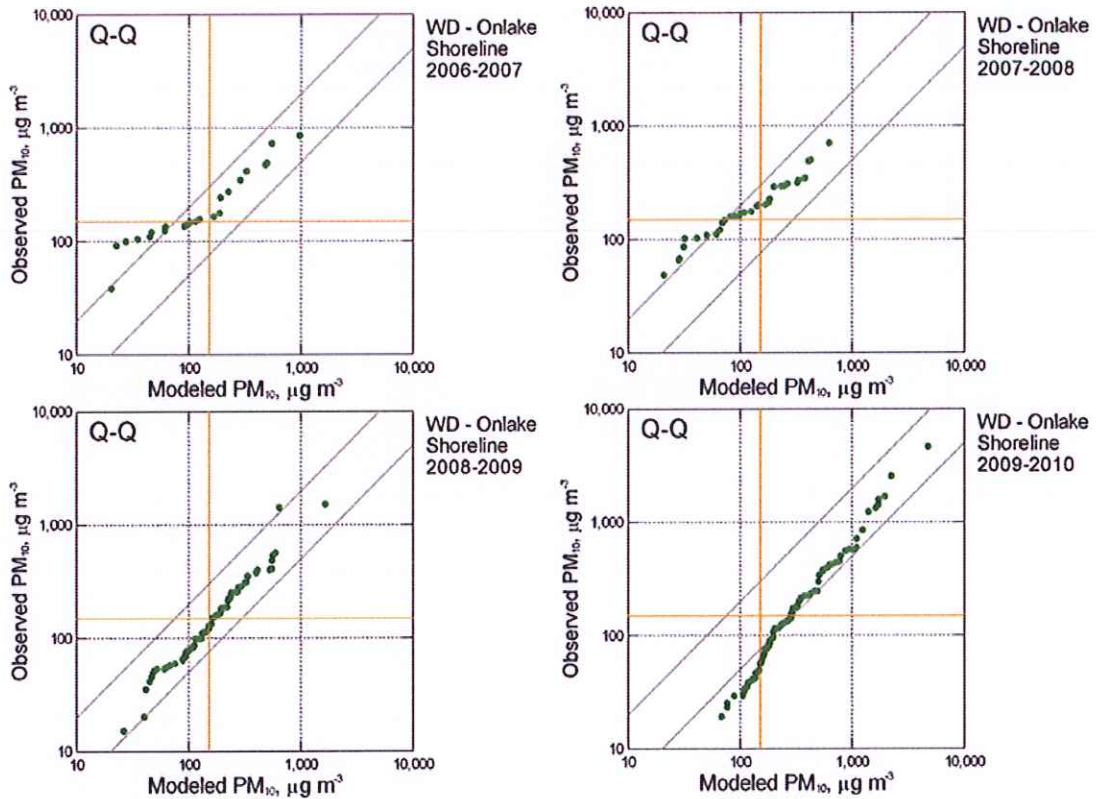

¹⁸ This value in 2009-2010 is being driven by the four highest modeled concentrations, which all occur at Lizard Tail. If these four highest points are removed, the R² drops to 0.28. This does not accurately represent the performance elsewhere on Owens Lake.

FIGURE 5-7. FRACTIONAL BIAS BY DUST SEASON

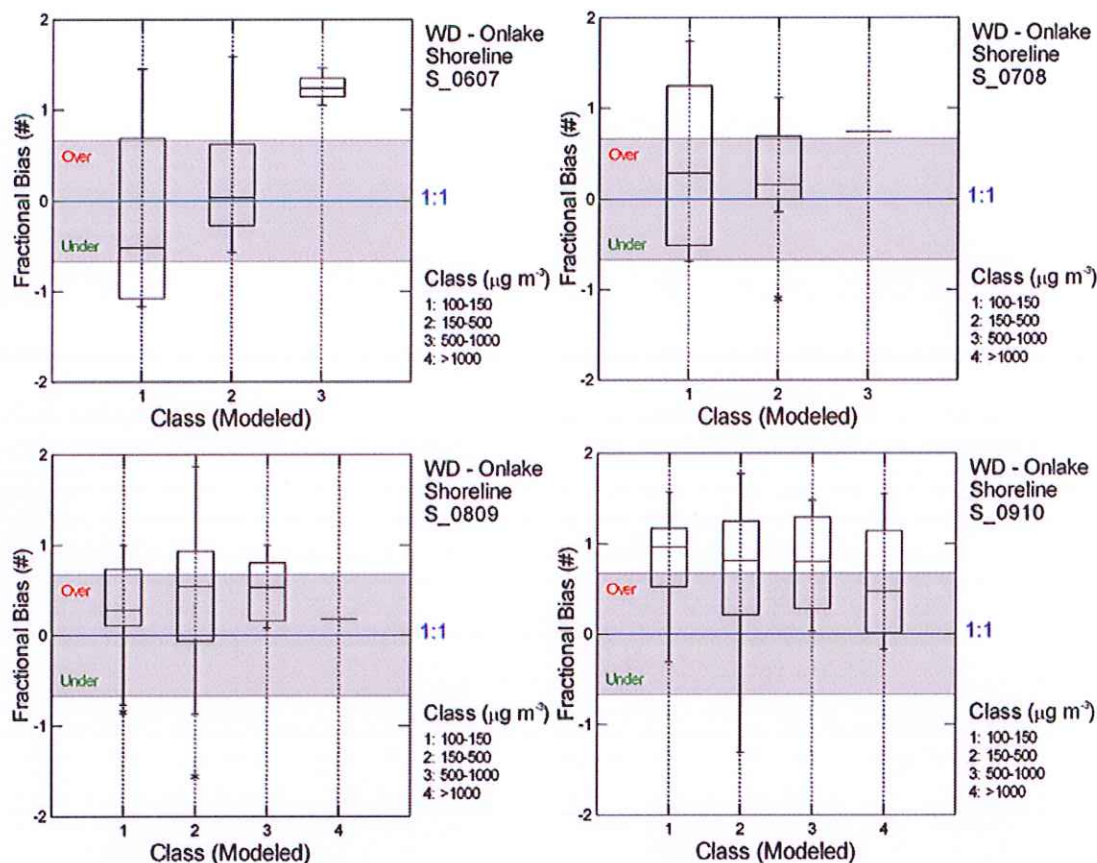

5.2.3 Results by Monitoring Site

This section summarizes model performance results on a monitoring-location basis. This approach is consistent with model performance comparisons prepared by the District (District 2001 and 2011). Evaluation of the model on this basis allows for examining the variation in performance based on location, as one would expect, for example, that model performance would decrease with increasing distance from a source area. In addition, several monitors have nearby off-lake source areas located between the shoreline and the monitor that potentially affect the accuracy of model predictions.

5.2.3.1 Scatter Plots with Regression Analysis

Figure 5-8 and Figure 5-9 show the scatter plots of the observed 24-hour PM_{10} concentrations by location against the model predictions. At all the monitors, with the exception of Lizard Tail, there is usually no relationship, and occasionally a weak relationship, between the observed and modeled concentrations. This visual assessment is confirmed by the results of the regression analysis (Table 5-3). The R^2 value is only

statistically significant at the Lizard Tail and Dirty Socks monitors. At the other seven locations, model predictions are not statistically related to the observations, with the model explaining zero to 14 percent of the variability of the observations (Table 5-3). In addition, although the model is significant at Dirty Socks, it also has a significant bias. Thus, of the nine locations, Lizard Tail is the only one where there is a statistically significant, non-biased relationship between modeled and observed concentrations. It should be noted that the relationship between modeled and observed concentrations at Lizard Tail is strongly driven by the four highest data pairs, those exceeding $1,000 \mu\text{g m}^{-3}$ (Figure 5-9). Removing these four data pairs, the regression model at Lizard Tail is not significant, is statistically biased, and has an R^2 value of only 0.15, compared to 0.58 with the four points included (Table 5-3).

TABLE 5-3. REGRESSION SUMMARY BY MONITORING LOCATION

Monitoring Location	Sample Size (N)	R^2	Bias Significant ($p < 0.05$) ¹	Significant Model ($p < 0.05$) ²
All	241	0.11	Yes	Yes
Lone Pine	13	0.08	Yes	No
Keeler	14	0	Yes	No
Dirty Socks	67	0.15	Yes	Yes
Olancha	28	0.09	No	No
Flat Rock	30	0.03	Yes	No
Shell Cut	31	0.01	Yes	No
Ash Point	14	0.09	No	No
Lizard Tail	23	0.58	No	Yes
North Beach	21	0.14	Yes	No

¹ Indicates a 95 percent confidence level that the bias (the intercept of regression line) is different from zero.

² Indicates a 95 percent confidence level that the model (the slope of the regression line) is different from zero.

5.2.3.2 Quantile-Quantile Plots

The Q-Q plots by each location (Figure 5-10 and Figure 5-11) indicate that the ranked data pairs are predominantly within a factor of two, indicating that the Dust ID model reproduces the distribution of the observed PM_{10} concentrations reasonably well. However, partially due to insufficient sample size (Table 5-3) many of the Q-Q plots do not show the desired approximate straight line through the data (including the Lizard Tail location).

5.2.3.3 Fractional Bias

Fractional bias plots were not prepared on a location basis because the number of data points at many of the locations was insufficient to build reliable fractional bias summary plots.

FIGURE 5-8. SCATTER PLOTS BY MONITORING LOCATION, 2006–2010 (PART I)

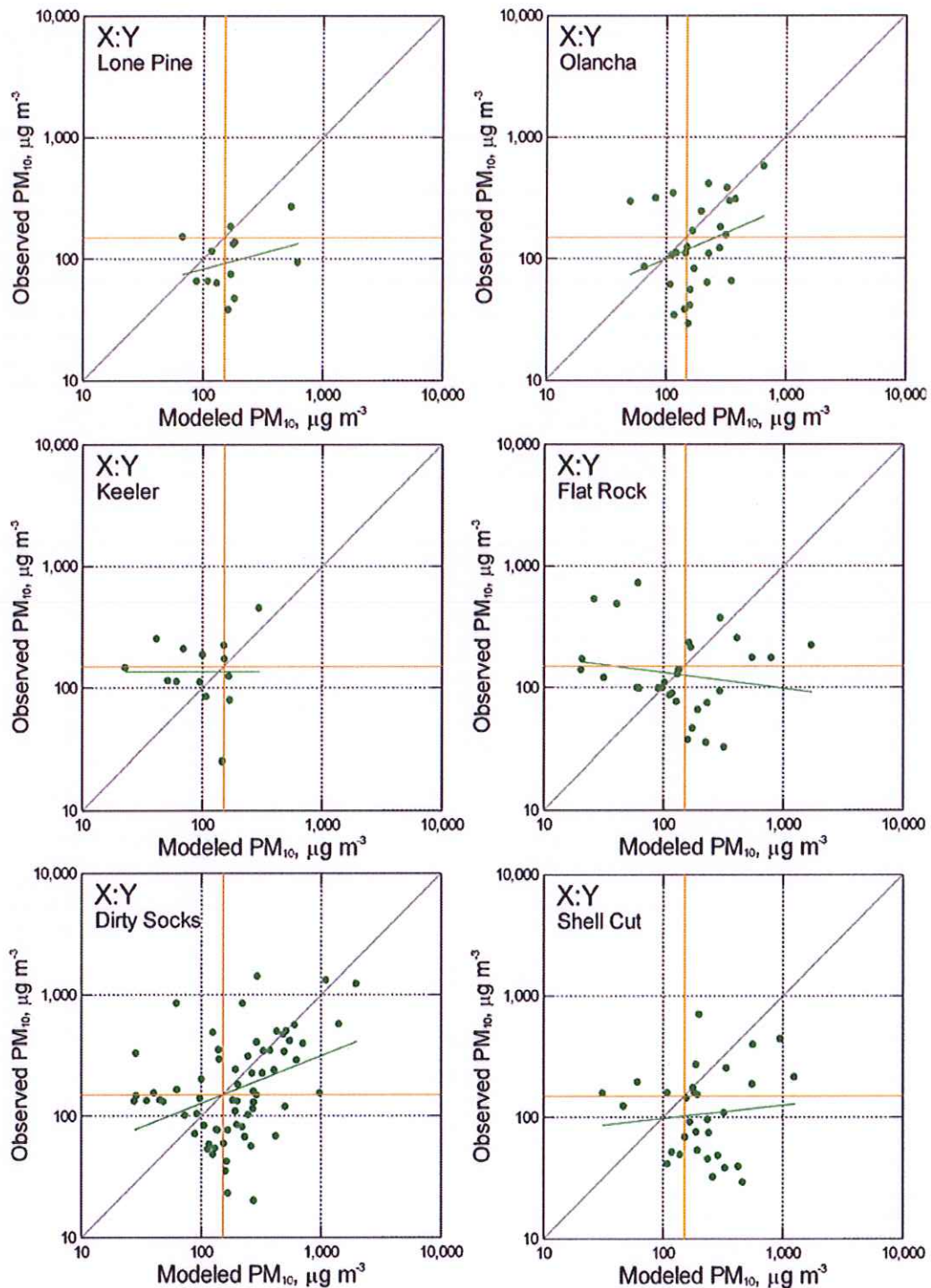

FIGURE 5-9. SCATTER PLOTS BY MONITORING LOCATION, 2006–2010 (PART II)

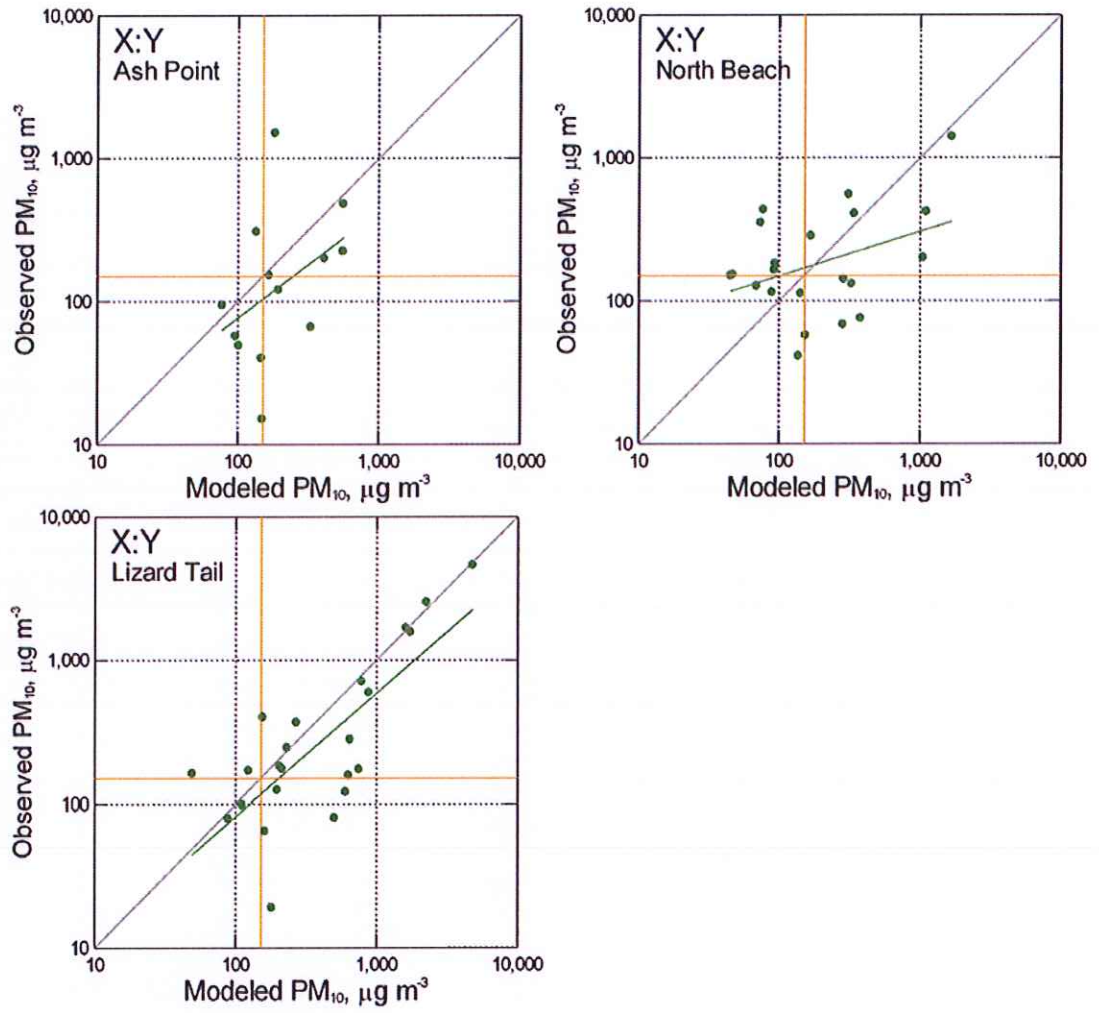

FIGURE 5-10. Q-Q PLOTS BY MONITORING LOCATION, 2006-2010 (PART I)

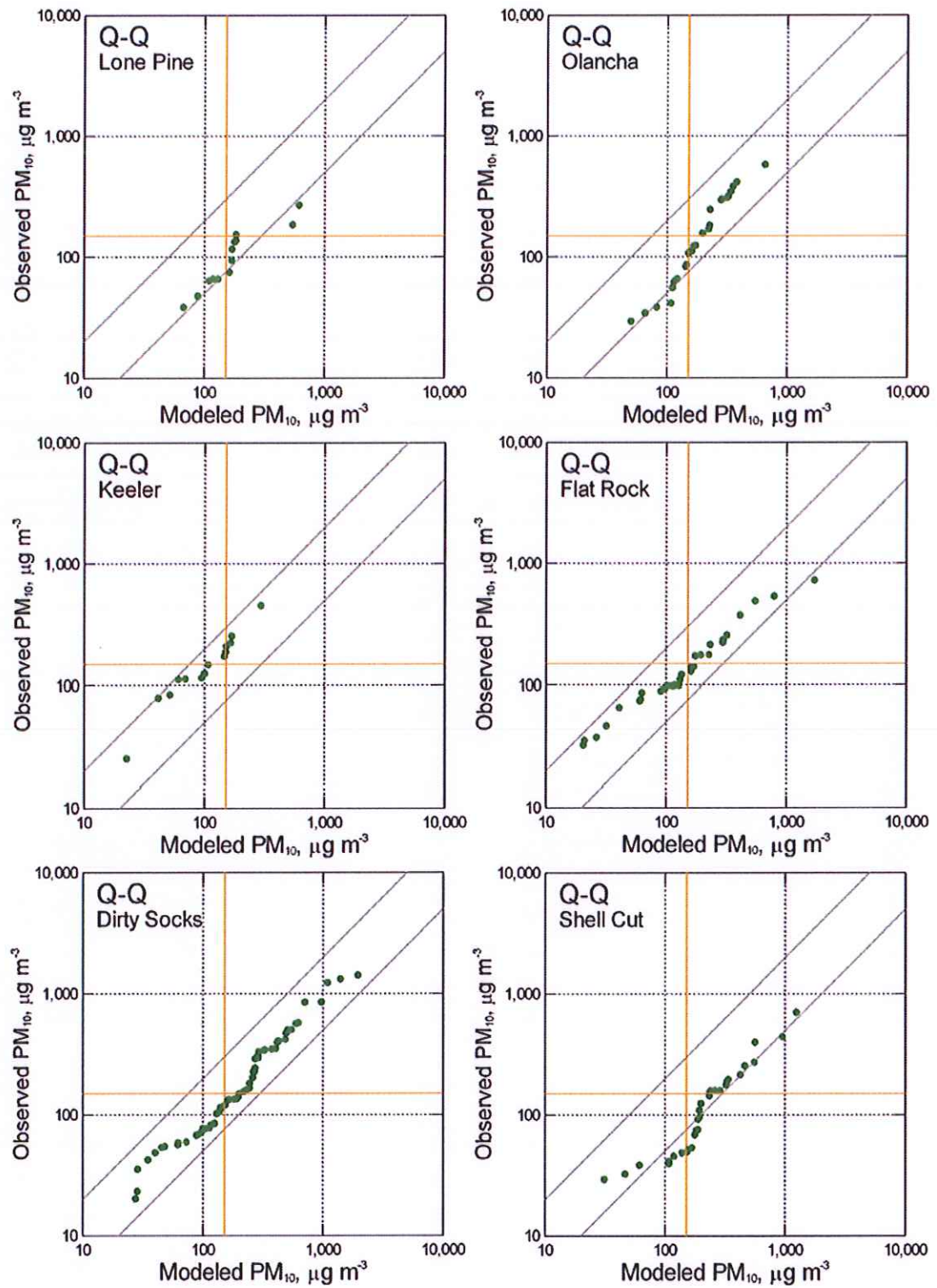
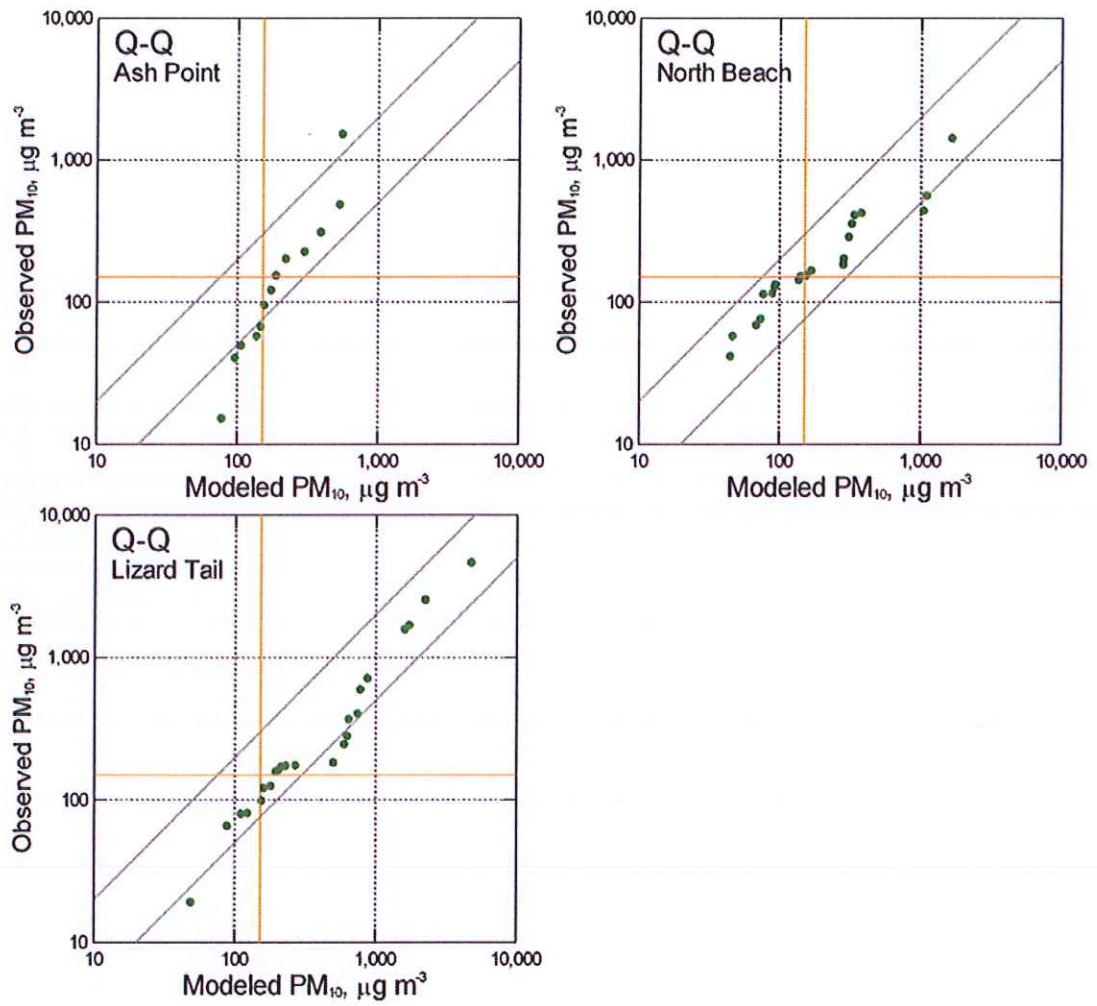

FIGURE 5-11. Q-Q PLOTS BY MONITORING LOCATION, 2006-2010 (PART II)



5.3 Discussion

Table 5-4 summarizes the model performance results presented earlier in Section 5.2. Based on the full four-year period of the Preliminary SCR Determination, only the unpaired Q-Q plots show that the model performs reasonably well. However, the more appropriate performance measures that compare modeled and observed concentrations in space and time – that is, paired regression analysis and paired fractional bias – indicate that the model performs poorly. The regression analyses show that the relationship between observed and modeled 24-hour PM₁₀ concentration is unbiased and statistically significant at only one of nine PM₁₀ monitors, and for only one of the four dust seasons. Although statistically significant, the model combining all locations over the entire period is significantly biased and explains only 11 percent of the variability in PM₁₀ concentrations. This means that nearly 90 percent of the variability between observed and modeled concentrations cannot be distinguished from random data noise.

This poor performance is due variously to random error, uncertainties in model inputs (for example, the inability of a single Sensit to characterize sand motion over a relatively large and spatially variable emissive area), and uncertainties inherent to the modeling process itself (for example, the modeled versus actual wind fields). Just as important, the Dust ID model systematically over-predicts the true PM₁₀ concentrations, especially in the lower concentration classes.

An evaluation of the Dust ID model based on an annual dust-season basis shows poor performance in all four years: 2006–07, 2007–08, 2008–09, and 2009–10. Over these four dust seasons, only the 2009–2010 dust season provides an unbiased and statistically significant regression line ($R^2=0.42$; Table 5-2). However, the better performance during the 2009–2010 season is largely due to the four highest concentrations days observed at the Lizard Tail monitor; exclusion of these four days (less than 4 percent of all data points) reduces the strength of the regression model considerably. In addition, the Q-Q and fractional bias plots show that the Dust ID model systematically over-predicts the PM₁₀ concentrations during the 2009–2010 dust season, with the exception of the highest concentrations.

An evaluation of the Dust ID model based on monitoring location paints a similar picture. An unbiased and statistically significant model is achieved at only one of nine locations. At the other location, the model only explains anywhere from zero to 15 percent of the variability in the data. Although at Lizard Tail the model explains a large portion of the variability (R^2 values of 0.58; Table 5-3), this high value is solely driven by the four highest PM₁₀ concentration pairs. Exclusion of these four days from the analysis yields an insignificant regression model (R^2 values of 0.15) with a significant bias. The good agreement between model and observations at Lizard Tail on the high exceedance

days is most likely due to the fact that primary emissive areas striking this shoreline monitor are located immediately upwind. In general, the longer the distance between emissive areas and monitors, the greater the uncertainties in the model and the poorer the model can be expected to perform. Despite the relatively high R^2 values at Lizard Tail, the model also systematically over-predicts the correct observed PM_{10} concentrations, as indicated by the Q-Q and FB plots. This is consistent with a warning by EPA in early model performance guidelines, which states: *“Even good correlation can be obtained in cases where the magnitude of the peak levels are poorly predicted and for which a large overall bias exists”* (EPA 1984).

It is important to note that only five percent of the exceedances in the 2006-2010 SCR period occurred at sources adjacent to the Lizard Tail monitor. In other words, model performance at Lizard Tail is realistically only representative for five percent of the areas that went into the Preliminary SCR Determination. The other 95 percent are represented by the other eight monitoring sites, where the model performed poorly.

“Even good correlation can be obtained in cases where the magnitude of the peak levels are poorly predicted and for which a large overall bias exists.” (EPA 1984)

The performance of the Dust ID model also varies as a function of the PM_{10} concentration range. As noted previously, the only site to show a reasonably strong relationship between the modeled and observed concentrations is Lizard Tail. However, this strong relationship disappears when the four highest data points (exceedance days) are excluded. At Lizard Tail, the maximum modeled and observed concentrations were near $5,000 \mu\text{g m}^{-3}$. In contrast, at the other locations the maximum modeled concentrations varied from as low as $300 \mu\text{g m}^{-3}$ at Keeler (on-lake PM_{10} contributions only) to as high as $2,000 \mu\text{g m}^{-3}$ at Dirty Socks. For comparison, over the SCR period of 2006 to 2010, the majority of the modeled shoreline PM_{10} concentrations, from both individual and multiple source areas, were flagged for control at concentrations of less than $1,000 \mu\text{g m}^{-3}$, and therefore fall into this range of relative uncertainty.

TABLE 5-4. SUMMARY OF MODEL PERFORMANCE RESULTS

Evaluation Basis	Regression Analysis	Q-Q Plots (visual only)	Fractional Bias
Entire SCR Period	R^2 value 0.11: Nearly 90 percent of PM_{10} variability not accounted for by model.	<ul style="list-style-type: none"> Majority of points falls on stable straight line. However, model does systematically over-predict. 	<ul style="list-style-type: none"> Model systematically over-predicts observations. Over-prediction higher in low concentration ranges, less so in high concentration range.
Dust Season Basis	Model explains 5 percent or less of PM_{10} variability in first three seasons. In 2009-2010 better performance, but largely driven by only four high values at the Lizard Tail monitor.	<ul style="list-style-type: none"> Reasonable for 2006-2009 period. Although on straight line in 2009-2010 season, model systematically over-predicts. 	<ul style="list-style-type: none"> 2006-2009 tendency to over-predict but generally within factor of two. In 2009-2010, systematic over-prediction, especially at low PM_{10} concentrations.
Monitoring Location Basis	Reasonable relationship between model and observations at only one out of nine monitoring locations, Lizard Tail. Latter driven by only four high values.	Quite variable: Some sites have reasonable straight line through data, others skewed and low- and/or high-end.	Not completed; sample sizes too small.

5.4 Conclusions

For the period of this Preliminary SCR Determination, the Dust ID model performed poorly by two of the three statistical measures mutually agreed to by the District and LADWP. The model appeared to perform reasonably well, but only by the unpaired Q-Q plots, which do not consider time and space elements fundamental to calculating emission rates on the Owens playa. The more appropriate and relevant measures based on the paired regression statistics and paired FB showed that the model performed poorly. Model predictive capability was zero to very low, while the model systematically over-predicted observed PM_{10} concentrations. Based on the preponderance of the evidence, a reasonable conclusion is that the model performs poorly, and much too poorly for the intended purpose of identifying new dust control

areas on the Owens playa. This is consistent with EPA guidance. In its 1984 "Interim Procedures for Evaluating Air Quality Models (Revised)" (EPA 1984), the EPA recommends:

...the model should pass certain performance requirements that are acceptable to all parties involved. Marginal performance together with marginal determination on technical acceptability would suggest that the model should not be used.

Additional EPA guidance directly contradicts one of the major supporting principles of the Dust ID modeling process: the back-calculation (i.e., calibration) of the Dust ID model to produce hourly emission rates by bracketing the K factors over short periods of time (see Sections 3.3.6 and 4.1.6 of this document). The EPA states (see Appendix B, Attachment 9 of this document):

7.2.9 Calibration of Models

Calibration of models is not common practice and is subject to much error and misunderstanding. There have been attempts by some to compare models estimates and measurements on an event-by-event basis and then to calibrate a model with results of that comparison. This approach is severely limited by uncertainties in both source and meteorological data and therefore it is difficult to precisely estimate the concentration at an exact location for a specific increment of time. Such uncertainties make calibration of models of questionable benefit. Therefore, model calibration is unacceptable.

These results should be viewed by the District as a call for additional, immediate, and substantial improvements in the Dust ID program. The Dust ID model should not be used for this or any future SCR Determination until it has been refined according to the Expert Panel's recommendations and independently verified to perform within the range of scientific acceptability.

Appendix F

GBUAPCD Response to Comments



GREAT BASIN UNIFIED AIR POLLUTION CONTROL DISTRICT

157 Short Street, Bishop, California 93514-3537
Tel: 760-872-8211 Fax: 760-872-6109

AUTHORS' RESPONSE TO LADWP COMMENTS ON OTM 30

June 5, 2012

OTM 30, the Method to Quantify Particulate Matter Emissions from Windblown Dust was authored by Duane Ono of the Great Basin Unified Air Pollution Control District (District) and Ken Richmond, of ENVIRON International, Corp. It was reviewed by a committee formed at the Center for the Study of Open Source Emissions led by Dr. Chatten Cowherd, and by the US Environmental Protection Agency's Measurement Technology Group. The following are the authors' responses to comments on OTM 30 submitted by the City of Los Angeles Department of Water & Power (City) to the EPA (letter dated May 29, 2012). OTM 30 is based on the Owens Lake Dust Identification Program (Dust ID) which has been in operation at Owens Lake, CA since 1999. Some of the City's comments regarding the Dust ID model may also apply to OTM 30. The numbered responses below correspond to the comment numbers in the margin of the City's letter, attached. Comments that are repeated in the City's letter may only be addressed once in the authors' responses.

Response #1:

OTM 30 is based on the Dust ID program used at Owens Lake. OTM 30 and the Dust ID program both use the same basic method of monitoring and modeling to estimate PM emissions for windblown dust source areas, but the Dust ID model takes this a step further by applying those emissions to the CALPUFF dispersion model to estimate downwind impacts. The District's use of CALPUFF for the Dust ID model is a regulatory requirement that only applies to Owens Lake, where the model is required to predict downwind impacts from each dust source area. OTM 30 is written as a method to estimate emissions. It is up to the user to decide if more will be done with those emissions, such as applying them to a model to predict downwind concentrations. The OTM 30 example case at Mono Lake, CA uses AERMOD and not CALPUFF. The selection of dispersion modeling methods to use with OTM 30 is left to the user. The use of monitoring and modeling as described in OTM 30 to estimate emissions from open sources is one of the oldest approaches that have been used by researchers. OTM 30 provides a procedure to apply this approach to quantify windblown dust emissions. See also Response #5 regarding peer review of the Dust ID Program by the California Air Resources Board and an expert panel.

Response #2:

Similar to response #1, OTM 30 is not required to use CALPUFF. Any EPA guideline model would be acceptable. The Mono Lake example case study described in OTM 30 uses AERMOD. Users should consult with their state regulatory agency and EPA prior to conducting a project if they intend to use OTM 30 for regulatory purposes.

As this comment applies to the Dust ID model applied at Owens Lake, EPA Region 9 approved the Dust ID model using the CALPUFF modeling system in 2010 as part of the approval of the 2010 PM₁₀ Maintenance Plan and Redesignation Request for the Coso Junction Planning Area. EPA specifically approved Board Order #080128-01, which includes provisions to control dust from Owens Lake using the Dust ID model. EPA found that due to their close proximity, emission reductions achieved at Owens Lake through this Board Order were necessary to maintain the PM₁₀ standard at Coso Junction. The use of the Dust ID method is currently approved by EPA for regulatory application only at Owens Lake, CA. (75 Fed. Reg. 54031) The use of CALPUFF and the Dust ID method were also approved by the California Air Resources Board in 2004 and 2008 with their approval of SIP revisions for the Owens Valley PM₁₀ planning area. (CARB, 2004; CARB, 2008)

Response #3

In response to the issue “(1) the OTM 30 model has not been evaluated as required by 40 C.F.R. Part 51, Appendix W, § 3.2.2.(a) and EPA Clarification Memo dated August 19, 2008;”

OTM 30 is not a model and the Guideline on Air Quality Modeling section on non-guideline models is not relevant in this case.

Response #4

In response to the issue “(2) OTM 30 requires the calibration of CALPUFF with its own results in violation of EPA modeling rules (40 C.F.R. Part 51, Appendix W, § 7.2.9);”

OTM 30 does not require calibration of a model. Model results and monitor concentrations are compared for seasonal periods that may last for months to infer seasonal K-factors from the median value from all valid hourly K-factors to yield a seasonal value that is applied with the hourly sand flux to estimate emissions. These seasonal K-factor periods are generally on the order of months and sometimes for over a year. It should be noted that the real driver of the PM emissions is the hourly sand flux, which may change by three orders of magnitude. The variation of seasonal K-factors is normally within one order of magnitude.

Further in the City’s comments, they incorrectly imply that each modeled hour is calibrated to the hourly monitor readings and that is why the daily monitor and model trends can match so well. See response #35. The assertion that the method uses hourly model calibration is not true, nor is it recommended in OTM 30.

After the emissions are determined they may be used with a dispersion model to calculate downwind concentrations using whatever model is appropriate; not necessarily the CALPUFF model.

Response #5:

In response to issue “(3) a two-year objective scientific peer review of the Dust ID model shows that the Dust ID model cannot accurately predict PM₁₀ concentrations in time and space,”

there have been three different reviews of OTM 30 and the Dust ID Program; 1) a series of reviews of the method by the Center for the Study of Open Source Emissions (CSOSE) in the process of conversion to EPA's OTM format and an EPA review of the method after it was submitted by CSOSE, 2) an Expert Panel review of the Dust ID Program and 3) a review of the Dust ID Program by the California Air Resources Board. These reviews are discussed below.

CSOSE & EPA Review: In 2011 and 2012, the text and content of OTM 30 were reviewed by a committee formed at the Center for the Study of Open Source Emissions (CSOSE) led by Dr. Chatten Cowherd, and by the US Environmental Protection Agency's Measurement Technology Group. Dr. Maarten Schreuder, an employee of Air Sciences, who is contracted with the City of Los Angeles Department of Water & Power, is a participant in the CSOSE conference calls and was initially included on the OTM 30 review committee, but later declined to participate on the review committee. The City did not take advantage of Dr. Schreuder's involvement to voice their concerns when OTM 30 was being developed.

Expert Panel Review: From 2008 through 2010 the City and the District met with an Expert Panel composed of Dr. Chatten Cowherd (MRI Global), Dr. John Gillies (Desert Research Institute) and Dr. Larry Hagen (ret. USDA-ARS) to evaluate the Dust ID program and recommend changes that could improve the program. The Expert Panel review found the Dust ID method to be highly successful at Owens Lake and made recommendations that instead of moving away from the Dust ID method, the method be supplemented by more intensive monitoring, including collecting sand flux and met data for every 5-minute period and modeling every 5-minute period as opposed to the more traditional hourly modeling. They also recommended adding more PM₁₀ monitors to the network to improve model predictions. In a recent communication to the EPA, Dr. Chatten Cowherd wrote,

"I have reviewed the final report issued by the Expert Panel (of which I was one of three members) on May 11, 2010. After two years of mediating technical discussions between the City and the District, we concluded that the method captured in OTM 30 should continue to be applied to achieve the required additional dust reductions. We recommended ways in which we believed that the method could be 'further strengthened' by more intense application of the method (such as by increasing the number of air quality monitoring stations). It was our opinion that implementation of these steps (at the expense of the City) should aid in meeting the requirements of identifying additional areas of the dry lakebed for dust control.

As I stated in my previous message, the method captured in OTM 30 has a long history, starting with a basic concept called upwind/downwind sampling. It was one of the early methods to be identified in EPA-funded studies for use in characterizing fugitive dust sources. In a paper that I presented at the annual A&WMA conference in 2001, 'Overview of Sampling Methods for Fugitive Sources,' it states:

'The oldest approach used to develop emission factors for open dust sources is the upwind/downwind method [1] that relies on the application of a steady-state dispersion model to back calculate an emission rate from particulate concentrations measured at ground level. The

upwind-downwind method involves the measurement of airborne particulate concentrations both upwind and downwind of the pollutant source.’

[¹Kolnsberg, H. J. Technical Manual for the Measurement of Fugitive Emissions: Upwind/Downwind Sampling Method for Industrial Fugitive Emissions. EPA-600/2-76-089a, NTIS Publication PB253092, 1976.]”

(Cowherd, 2012)

Response #6:

In response to issue “4) *the recommended specific changes that were deemed necessary to address specific severe deficiencies in the Dust ID model have never been implemented,*”

contrary to the City’s statement that the Expert Panel “*recommended specific changes that were deemed necessary to address specific severe deficiencies in the Dust ID model have never been implemented,*” the District did make changes to the program, and we would not classify them as “*severe deficiencies*” by any standard of comparison. Following the Expert Panel meetings, the District developed a list of action items with the City to improve the Dust ID Program at a meeting on November 1-2, 2010 (AR:4g:2831-2832.)¹ and scheduled a follow-up meeting for February 2, 2011. (AR:4g:2833.) The City cancelled the February meeting the day before it was to take place and refused requests to reschedule. (AR:4g:2834.) Despite the lack of cooperation from the City, the District made changes to the program that did not require mutual agreement with the City. This included: adding two more shoreline PM₁₀ monitors, adding two portable PM₁₀ monitors, adding and reconfiguring sand flux sites to improve density and coverage, and using upwind and downwind monitors to improve K-factors. As recommended by the Expert Panel, but not fully implemented because it requires the mutual consent of the City, the District also did the following: refined the modeling period from hourly model increments to 5-minute modeling increments, proposed new default K-factors, analyzed K-factors and wind directions to help identify hotspot areas, and investigated improvements in source area delineation methods. (AR:2a:1069-1074.) A copy of the final report of the Expert Panel is included as Exhibit 1.

ARB Review of Dust ID Program – As part of a current appeal of an order for the City of Los Angeles to control additional dust source areas at Owens Lake, the California Air Resources Board reviewed the Owens Lake Dust ID modeling method. The ARB staff assessment states, “*ARB staff has reviewed the District’s description and the relevant citations in the record and finds the approach, including the use of CALPUFF, to be a sound and effective method for determining areas needing control.*” (SA:9)² The ARB staff assessment further supports the use of CALPUFF as the

¹ The citation and others that start with “AR” are from the administrative record for the City’s appeal hearing before the California Air Resources Board scheduled for June 15, 2012. The numbers refer to the part of the administrative record, e.g. 4g, and the pages, e.g. 2831-2832. The administrative record and these references can be found on the District’s website at <http://www.gbuapcd.org/owenslake/2011SCR/CARB-Appeal/AdministrativeRecord.htm>.

² This citation refers to the CARB staff assessment (SA, followed by page number) that was written for the City’s appeal hearing scheduled for June 15, 2012. The Staff Assessment is included as Exhibit 2. It is also on the District website at <http://www.gbuapcd.org/owenslake/2011SCR/CARB-Appeal/CARBStaffAssessment2011SCRDAppeal20120430.pdf>.

EPA recommended model, finds that the City misinterprets EPA guidance on model calibrations and supports the model and monitor comparisons to improve the accuracy of the emission estimates, and they found no fault in the model performance, stating that, “[Additionally,] the number of individual emissive source areas on the lakebed during any high wind event is far higher than the number of sources simulated in most field studies. (AR:1f:48866-50981.) Given these complexities, it is not realistic to expect Owens Lake modeling to meet the performance criteria suggested by U.S. EPA for more typical stationary source permitting applications.” (SA:12-13) A copy of the ARB staff assessment is included as Exhibit 2. In this exhibit we have highlighted the portions that pertain to the Dust ID modeling issues.

Response #7

Section 4.1 of OTM 30 addresses “unmonitored sources of PM” and says, “[It] is important that all PM sources that contribute to downwind monitor concentrations are included in the dispersion model.” (emphasis added) This comment addresses a long-standing disagreement that the City has had with the District and the Dust ID Program at Owens Lake and is not applicable to the content of OTM 30.

Response #8

This is from Section 1.1 at the beginning of OTM 30. The authors believe OTM 30 Sections 4.1 – unmonitored sources of PM and 7.1.1 - Sensit and CSC monitor locations adequately address these concerns later in the method description. See also response #7 regarding unmonitored sources.

Response #9:

This is from Section 1.2 at the beginning of OTM 30. The authors believe OTM 30 Section 7.1.1 - Sensit and CSC monitor locations adequately address these concerns later in the method description.

Response #10:

K-factors derived for PM_{2.5} or PM₁₀₋₂₅, are very likely to be related to K-factors for PM₁₀ by the same proportions as their concentrations as measured at downwind monitor sites. Since PM₁₀ and saltation are relatively proportional as found in K-factor analyses, and PM₁₀ and PM_{2.5} have been observed to be relatively proportional, it is mathematically reasonable to expect K-factors for PM_{2.5} and PM₁₀₋₂₅ to have similar proportional relationships. Shown in Figure 1 is a time-series plot of the PM_{2.5} to PM₁₀ ratios for PM downwind of the Keeler Dunes at Owens Lake (hours with wind speed greater than 7.5 m/s at 10 m). Although there are fluctuations in the ratio, the median value is 0.25, which is what we would expect to see as the ratio of K-factors for PM_{2.5} and PM₁₀. By inference, the ratio of the PM₁₀₋₂₅ K-factor should be about 0.75 of the PM₁₀ K-factor. By allowing other researchers to use OTM 30 we will learn more about these relationships and about fine and coarse PM ratios at other locations. The authors believe the application of OTM 30 to the PM_{2.5} and PM₁₀₋₂₅ fractions of PM₁₀ is technically sound guidance.

Figure 1. Time-series plot of the PM_{2.5} to PM₁₀ ratios for PM downwind of the Keeler Dunes at Owens Lake.

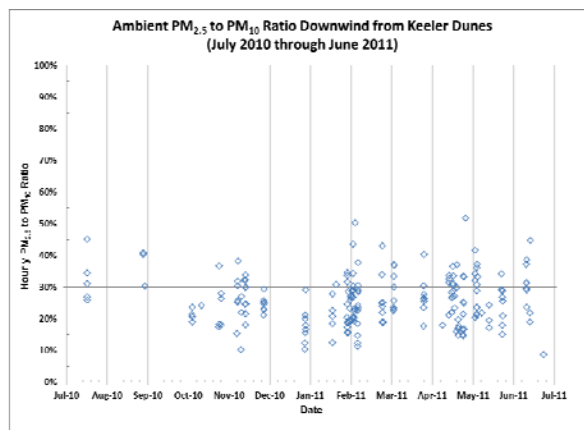

Response #11:

Two published papers and the 2008 Owens Valley PM₁₀ SIP were cited to support the statement that soil textures or chemistry can affect K-factors. They all addressed this relationship. For example, an excerpt from the 2008 Owens Valley SIP discussed some of the observed trends in K-factors:

“In addition to the South area, three other areas of the lake bed were identified for the spatial K-factor sets: the Keeler dunes, the Central area and the North area. The boundaries of the four areas, which are shown on the map in Figure 4.2, were delineated by a survey of the surface soil textures. All four areas showed temporal K-factor trends, as well as some differences that may be attributed to different soil textures. Figures 4.9 through 4.11 show the hourly and storm average K-factors for the Keeler dunes, Central area and North area from January 2000 through June 2002. Temporal cut-points for each area were subjectively selected based on shifts in the 75-percentile storm-average values, which also appeared to correspond to seasonal shifts in the observed surface conditions, such as efflorescent salt formation or surface crusting.” (excerpt from Section 4.3.4 Temporal and Spatial K-factors) (GBUAPCD, 2008)

The authors believe the information provided in the cited references is sufficient to support the statement in OTM 30 that soil texture and chemistry can affect K-factors.

Response #12:

This was discussed in responses #2 and #6. As previously stated users of OTM 30 should consult with EPA and their state air agency if they plan to use this method for regulatory purposes. It should also be noted that the referenced EPA memo was dated September 2008, which is nine years after the Dust ID effort was initiated at Owens Lake. Although the use of CALPUFF for the Dust ID program has the full approval of EPA and the state, this memo did not exist when the decision to use CALPUFF was made. The District does not plan to reprove to EPA that CALPUFF is appropriate for use with the Owens Lake Dust ID model.

Response #13:

While trends in K-factors may be inferred from predicted concentrations, the actual variable is a factor used to calculate the emission flux from the saltation flux. The definitions for the emission flux, K-factor, saltation flux (or sand flux) are intended to refer to their application in equation 1 of the OTM. This is the equation used to calculate PM emissions after the data has been collected and analyzed.

Response #14:

The Cox Sand Catcher does measure flux over a given period of time. The inlet opening has a cross-sectional area for the capture of the sand moving horizontally and the time period that was provided in the parenthesis after the word “period...” in the cited, but truncated, quotation: “(e.g. *monthly sampling period*).” This would yield the traditional flux dimensions [mass/area/time]. As discussed in Section 14.0 of OTM 30, some researchers may want to use Cox Sand Catchers by themselves as simple survey tools. In that case, it is not possible to time-resolve the monthly catches with the Sensit to determine flux rates over a shorter period of time.

Response #15:

The linear relationship of the Sensit reading to the sand mass referred to in Section 3.7 is about the relationship between the Sensit readings collected over the same period of time as the sand catch at the same site. The City’s comment tries to confuse something that is done on rare occasions by trying to make it sound like a normal part of the routine. Their discussion applies to cases when the sampling collection tube has overflowed because it was left in the field too long, or on rare occasions when a sand catch sample is spilled and an attempt is made to salvage the data because losing one sample point could jeopardize the entire network. This issue is addressed in Section 8.1.5 of the OTM Quality Control section in a discussion on missing sand catch mass data. Both of these situations can be avoided by careful collection of samples and by paying attention to activity levels in the study area.

Response #16:

Section 7.1.1 also says that “*Sensits and CSCs should be collocated at sites 100 to 1,000 m apart.*” The OTM was written so that it was not overly prescriptive. Since study areas can be quite unique, there was no simple means of determining a technically defensible network density that applied to all locations. In addition, a sand flux network comparison at Owens Lake found that having more sites is not necessarily that much better. At Owens Lake a network using four sand flux monitoring sites to represent a four square kilometer area had only a 2% difference in the average flux rate over a one to two week sampling period as compared to the average of thirty sampling sites for the same area. (Ono, 2010) The sand flux network provides time-resolved information that identifies areas that are eroding and at what level. The calculation of PM emissions is mostly dependent on the PM reading at the downwind monitor site. As discussed in Section 7.1, “...*because the dispersion model uses the downwind PM monitor to refine the PM emission estimates, any measurement bias in the sand flux*

measurement as compared to the actual average will be compensated for by adjustments in the K-factor to yield the correct PM emissions.”

More sites will certainly provide better information on smaller areas, but researchers should not be required to meet minimum network density requirements in order to implement a study using OTM 30. There is no one-size fits all network solution.

Comments on this section also address the precision of the CSCs and Sensits. The intent of the discussion in OTM 30 was to explain that it was unnecessary to have two CSCs and two Sensits to determine measurement precision at a single location. If the user has extra sand flux instruments, they would be more useful for increasing the network density and sampling other locations. The variability of sand flux within a sampling area ($\pm 60\%$ for one site to represent the average sand flux for the same square kilometer area as stated in their comments) is normally higher than the error associated with the measurement uncertainty of the instrument ($\pm 3\%$ as stated in their comments). Even this 3% measurement uncertainty with the CSCs may be due to source variability (instruments were a meter apart) and not measurement uncertainty.

Response #17:

In Section 10.5 of OTM 30, step 3 explains how to generate seasonal K-factors:

“Step 3: Seasonal K-factors can be generated from screened hourly K-factors by looking for shifts in K-factor values. The use of seasonal K-factors provides a longer-term stable value that helps to compensate for uncertainty in hourly K-factors associated with sand flux estimates, dispersion model assumptions, and PM₁₀ monitor measurements. It is recommend that seasonal K-factors be based on the geometric mean value of K-factors during each period, and that there be 9 or more hourly values in a seasonal period. This value will provide good seasonal estimates of median PM emissions. For regulatory purposes, the 75-percentile seasonal K-factor has been used to estimate the potential PM emissions for dust control purposes.”⁴

Because the user(s) select the seasonal K-factor periods, two modelers may select different cut points for those periods and will get different results for their emission calculations. An example of this is seen in the City’s Figures 1b and 1c. In this example, both K-factor sets may yield reasonable emission estimates, and they might be about the same for the total emissions for the entire year. If the modelers want to know which cut-points are likely to provide the better emission estimates, they should compare the model predictions using each set of K-factors to the monitor concentrations for the same periods. Since there may be as few as nine hourly K-factors representing hundreds of hours of modeled dust activity it is uncertain how well those seasonal K-factors will fit the hours that were not used to develop the seasonal values. Model performance comparisons have been useful at Owens Lake to evaluate different sets of seasonal default K-factors and episode K-factors. Model performance comparisons should follow the procedures discussed in Section 11.1 for Method Performance and in the sample application in Section 12.0.

The City suggests that the K-factors shifts may be caused by uncertainty. As discussed in Step 3 above, there is uncertainty in the sand flux estimates, dispersion model assumptions and PM₁₀ monitor measurements that contributes to the scatter in the hourly K-factors. The recommendation to use the geometric mean value of the hourly K-factor values to determine the seasonal K-factors assumes this uncertainty is random about the geometric mean value. If the uncertainty causes a shift in the K-factor, this could be detected as a seasonal shift, but it will not affect the PM emission calculation, since the emissions are primarily adjusted based on the PM monitor concentrations. As discussed in Section 7.0, *“because the dispersion model uses the downwind PM monitor to refine the PM emission estimates, any measurement bias in the sand flux measurement as compared to the actual average will be compensated for by adjustments in the K-factor to yield the correct PM emissions.”*

The City’s example K-factor plots in their Figures 1a, 1b, and 1c show that the K-factor cut-points seem to inexplicably change for no apparent reason. These Owens Lake plots are a good example of why the selection of seasonal cut-points is left to the OTM user. Some of the seasonal cut-points at Owens Lake are selected based on shifts in K-factors observed in other areas, or they may be default seasonal cut-points that were agreed to in the Dust ID model procedures for Owens Lake. The South Area K-factors shown in these plots often have similar seasonal K-factor patterns to the Central Area, and the seasonal cut-points for the two areas are sometimes made to match if there is a distinct shift in one of the areas. It should be noted that the City can, and has recommended other seasonal cut-points to the District for application at Owens Lake that have been used with the Dust ID model. Because the emissions from each source area are derived by multiplying the K-factor by the sand flux, the sand flux numbers have the biggest effect on the emissions calculation. See response #4 regarding the magnitude variation of K-factor values and sand flux rates.

Response #18:

The recommendations in OTM 30 are intended to provide researchers with guidance to successfully implement the method, while at the same time not being overly prescriptive, because as the City’s comment acknowledges, *“[the] application of the method will be different depending on the setting.”* Differences in the setting certainly consider the physical location of the project, but it may also include whether this project is being done as an academic research project, as a general survey of erosion areas, or for a regulatory purpose.

Response #19:

OTM 30 was written to conform to the format of other OTMs on the EMC website and was reviewed by the EPA staff with expertise in quality assurance. The entire text of OTM 30 addresses all necessary elements of the data quality objectives for implementing this method and the measurement quality objectives. They are summarized in the appendices (A, B, C and D) in OTM 30. The content of the OTM 30 document can be used as a template to develop DQOs and MQOs for specific projects. Project managers should use the OTM guidance to develop project-specific DQOs in their test plans that identify data collection needs that are appropriate for their test area, modeling method and data screening criteria.

Response #20

OTM 30 is independent of the model employed, so different models will have different meteorological parameters. Appendix A provides a list of meteorological measurements that are required and optional for each test site. On-site data for all meteorological parameters is preferable, but in the opinion of the authors some of the parameters are less influential with the model under the high wind conditions that are associated with windblown dust.

Response #21

The authors believe the quoted statement in Section 4.1 of OTM 30 adequately addresses the City's comment; "*It is important that all PM sources that contribute to downwind monitor concentrations are included in the dispersion model.*" (emphasis added). See also comment and response #7.

The 20% criterion for PM₁₀ impacts from other sources is a suggestion for sources that should be included in the background concentration. These sources are not missing they should be included in the background. To help put the 20% into perspective, Figure 9 from OTM 30 shows that hourly K-factors for short periods may range from 1×10^{-5} to 10×10^{-5} ; a 1000% difference from the lowest to highest value. Variations less than 20% are not significant as compared to this 1000% range, unless they are consistent emission sources that would bias the results, in which case they should be included in the background concentration.

Response #22

The placement of the monitors is dependent on the nature of the application and the user should use their judgment to determine the appropriate locations for monitors. See also response #18. The OTM 30 example places the downwind monitor in a downwind source area (distance = zero), and the Dust ID Program at Owens Lake has a monitor to source area distance criteria of 15 km for calculating K-factors. Presumably, such decisions would be addressed by the user in a modeling protocol or project plan. See also responses #7, #20 and #21 regarding network design and unmonitored sources.

Response #23:

The downwind PM concentration is the most important variable in the method, because this is the measurement that the model is using to back-calculate K-factors and to relate to the sand flux network. A poorly located PM monitor that has few dust impacts from the source area will have little value for calculating emissions. Sand flux data, from even a few sites can provide information on erosion activity, but it is more useful if there is a K-factor to translate that information to a PM emission rate. See also responses #18 and #22 regarding network design.

Response #24

See authors' responses #7, #21 and #23. To get the background value for the Mono Lake study, the average PM₁₀ (=background) from the upwind Lee Vining Partisol PM₁₀ monitor was used for the

period prior to July 1, 2010 for days when the hourly average winds at Mono Shore were greater than 7.5 m/s and from the south ($>90^\circ$ and $<270^\circ$). The average was $16 \mu\text{g}/\text{m}^3$. There are no significant PM_{10} sources between the Lee Vining monitor and the study area. It is mostly water, so this is a good site to get an upwind background concentration. Note that the City may not know that days with wildfire smoke were excluded from the background average. To confirm that this background concentration was appropriate, as part of this review we looked at the hourly PM_{10} data collected at the Mono Shore site that was used as the example in OTM 30 (July 2009-June 2010), and derived the hourly PM_{10} average for hours with high winds ($> 7.5 \text{ m/s}$) and when there was no sand flux in the test area. This alternate method of determining a background PM_{10} value for the test area yielded an average of $15 \mu\text{g}/\text{m}^3$, which confirms that the Lee Vining average provided a good upwind background concentration.

Response #25

Specific information regarding data review is included in Section 8.0 - Quality Control and suggestions for hourly K-factor screening criteria are listed in Step 2 of Section 10.4 of OTM 30. The authors do not agree that combining these discussions will improve the document.

Response #26

The City provides no citation for their statement that, *“Data collected at Owens Lake have shown that at low sand masses, the relationship between the Sensit response and the CSC mass ceases to exist, greatly increasing the uncertainty of the calculated hourly sand fluxes.”* The District previously investigated this issue and found out that the City was looking at a data set that included data in which sand catches less than 5 g were not used for the hourly sand flux calculations. At the time, many sites had sand catches in the hundreds or even thousands of grams, and the low sand mass catches ($< 5 \text{ g}$) were excluded from Sensit sand flux analyses. This led to the City’s mistaken conclusion that low sand masses were not related to Sensit readings. More recent sand flux analyses at Owens Lake use all sand catch masses down to 0.1 g and there is no apparent problem with the sand flux to Sensit relationships. Step 16 in Section 7.4 - Sample Recovery in OTM 30 specifies that samples are to be weighed to the nearest 0.1 g in the lab. Figure 2 is from a District report that was given to the City in February 2012. (Data Processing Team, 2012) See also response #15 regarding Sensits.

Response #27

Most of the City’s comments pertain to the Owens Lake Dust ID program and not OTM 30. As the comments relate to OTM 30, the authors believe that the suggested K-factor screening criteria contained in Section 10.5 are adequate.

The argument to have more stringent K-factor screens means that there will be fewer data points that pass the screens. If no data points pass the screens or fewer than nine points as suggested in the Section 10.5, then there would be no valid results. Having no results seems to be contrary to having a

Figure 2. The ability to measure low sand flux rates improved when CSC samples less than 5 g were weighed and used in the flux calculations. Before 2007 sand catches less than 5 g were treated as zero.

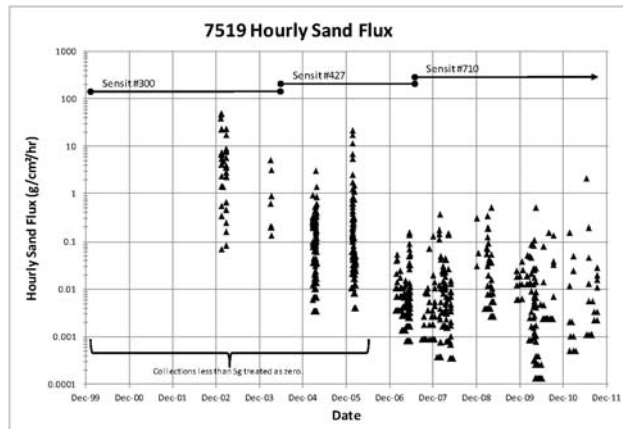

Table 1. Different K-factor screens applied to the Mono Lake data set showed little change in the geometric mean value.

K-factor Screen PM ₁₀ >	Number of Hourly K-factors	Geometric Mean
50 µg/m ³	249	2.4 × 10 ⁻⁵
150 µg/m ³	187	2.2 × 10 ⁻⁵
1500 µg/m ³	75	2.3 × 10 ⁻⁵

process that yields high quality data. To see how more stringent K-factor screens might affect a data set, we looked at the Mono Lake K-factors used in the OTM example. Since one would expect to have the highest quality data with higher PM₁₀ concentrations we compared the geometric means determined using PM₁₀ screens of 150 µg/m³ as used in the example to that for PM₁₀ greater than 1,500 µg/m³. We found that with the 150 µg/m³ screen we had 187 hours passing the screen with a geometric mean K-factor of 2.2 × 10⁻⁵, whereas with the 1,500 µg/m³ screen we had only 75 hours passing, but very little change in the geometric mean K-factor which was 2.3 × 10⁻⁵. We also looked at relaxing the K-factor screen to look at values down to 50 µg/m³, and this yielded more data points 249 and the geometric mean was 2.4 × 10⁻⁵. This 4% difference between the most stringent and most relaxed screens is not very significant. These results are summarized in Table 1. This exercise also showed the stability of the geometric mean. In addition, we looked at other K-factor sets at Owens Lake and found that the geometric mean values were also quite stable with different screening criteria. The wind direction screens are the most important screen to ensure that dust from the source area is impacting the monitor site and that you have a strong source-receptor relationship.

Response #28

About four years ago, the District found one batch of Sensits that gave a false signal at low temperatures. This was confirmed by putting the Sensit in the freezer and seeing activity readings. The manufacturer replaced these Sensits, but there may be a few still out there. This has not been a problem since that time. The authors do not believe this possible explanation needs to be included in OTM 30. See also response #26.

Response #29:

See response #27 regarding K-factor screens.

Response #30:

See responses #2 through #6 regarding the modeling method used for OTM 30.

Response # 31:

Appendix A to the City's letter is their analysis of the model performance for the Owens Lake Dust ID Program. Results from this more complex program are not included in OTM 30, which uses a simpler example of the method as applied at Mono Lake. The District's response to the City's model performance analysis for the Owens Lake Dust ID Program is included as Exhibit 3. Both of the documents were previously created as part of an analysis of additional areas that needed to be controlled at Owens Lake.

Response #32:

Figure 8 is provided as an example to the OTM user. Additional information on model performance and these plots can be found in Ono, *et al.* (2011) cited in OTM 30. This paper includes geometric as well as arithmetic model performance statistics. It should be noted that where the City sees no relationship between PM₁₀ and sand flux for sand flux less than 20 g/cm²/day, a keener eye may see that the relationship is pretty good except for a cluster of points where PM₁₀ ranges from 10 to 100 and daily sand flux is less than 1 g/cm²/day. Since there are only two Sensit sites to time resolve the data for the sand flux network, these outliers are likely caused by higher level erosion activity that is taking place at locations within the network, but those sites are not well-represented by the two Sensit sites. In this case, more Sensits would decrease the appearance of these outliers in the results.

Response #33:

The Mono Lake wind tunnel emissions algorithm in Figure 10 of OTM 30 shows the user the PM₁₀ emissions that would have been calculated for Mono Lake if OTM 30 was not employed. Similar wind tunnel tests have been done in other areas and emission estimates derived from these tests are routinely used to develop wind erosion emission inventories for many areas in the country. (WRAP, 2006) These tests usually include a handful of runs for each location that have been done once and

then are not repeated. Figure 10 shows the straight line relationship (on a semi-log plot) of the PM₁₀ emission rate as a function of wind speed for the wind tunnel method as compared to the scatter of emission rates as they compare to wind speed using OTM 30. The Mono Lake wind tunnel test was done in 1990 at a different location from the example study, but still on the north shore at Mono Lake. This information can be found in the Mono Basin PM₁₀ SIP, which was the cited reference for this information in OTM 30. (GBUAPCD, 1995)

Response #34:

See District response to the City's alternative analysis of model performance in Exhibit 3.

Response #35:

A single seasonal K-factor was used to generate the emissions for this example. The City's comment that, "... this event was heavily calibrated..." is not true. A single seasonal K-factor was based on 31 hourly K-factors from 10/16/2009 to 11/30/2009. The 4-order of magnitude correlation is legitimate.

Response #36:

See responses #6 and #35 regarding the OTM 30 method not being model calibration.

Response #37:

The method has been applied successfully at Owens Lake and Mono Lake for the entire range of PM₁₀ concentrations. As PM₁₀ concentrations at Owens Lake have come down, we are still finding success with the method. OTM 30 provides clear evidence of wind erosion activity through the collection of sand flux data. There is no dispute that erosion has taken place when there is physical evidence provided by material collected in the sand catchers. There is also no dispute that particulate matter emissions are associated with wind erosion of soils; it is only a question of how much. The use of downwind PM monitors and modeling provides a good opportunity to estimate those PM emissions. OTM 30 provides sufficient guidance in its current form for researchers to estimate those emissions.

Response #38:

See response #24 regarding confirmation of the background concentration for the OTM 30 example at Mono Lake.

Exhibits

Exhibit 1 – Expert Panel Report on Owens Lake Dust ID Program, 2010

Exhibit 2 – CARB Staff Assessment, 2012

Exhibit 3 – District Response to Alternative Analysis, 2011

References

CARB, 2004. California Air Resources Board, *Adoption and Submittal of the 2003 Amendment to the State Implementation Plan for Particulate Matter in the Owens Valley Planning Area*, Executive Order G-1 25-316, Sacramento, CA, February 27, 2004.

CARB, 2008. California Air Resources Board, *Relating to the Adoption and Submittal of the 2008 Amendment to the State Implementation Plan for Particulate Matter in the Owens Valley Planning Area*, Executive Order S.08.009, Sacramento, CA, June 11, 2008.

Data Processing Team, 2012. Data Processing Team, Memo to staff regarding Site 7519, Great Basin Unified Air Pollution Control District, Bishop, CA, January 11, 2012.

Cowherd, 2012. Cowherd, Chatten, “RE: Next Steps on OTM 30,” email from Cowherd (MRI Global) to Dennis Mikel (USEPA), May 11, 2012.

GBUAPCD, 1995. Great Basin Unified Air Pollution Control District, *Mono Basin Planning Area PM-10 State Implementation Plan*, Bishop, CA, 1995, 46-47.

GBUAPCD, 2008. Great Basin Unified Air Pollution Control District, *2008 Owens Valley PM₁₀ Planning Area Demonstration of Attainment State Implementation Plan*, Bishop, CA, 2008.

Ono, 2010. Ono, Duane, *Comparative Sand Flux Measurements Using BSNE and Cox Sand Catchers on the South Sand Sheet of Owens Dry Lake; 1/4/00 thru 7/3/00*, Great Basin Unified Air Pollution Control District, Bishop, CA, February 2, 2010.

Ono, *et al.*, 2011. Ono, D., Richmond, K., Kiddoo, P., Howard, C., Davis, G. Application of a combined measurement and modeling method to quantify windblown dust emissions from the exposed playa at Mono Lake, California. *J. Air & Waste Management Assoc.*, **2011**,

WRAP, 2006. *WRAP Fugitive Dust Handbook*, prepared by Countess Environmental for Western Regional Governors’ Association, Denver, CO, September 2006,
http://www.wrapair.org/forums/dejf/fdh/content/Ch8_OpenAirWindErosion_Rev06.pdf.

Appendix G

Dust ID Model Expert Panel Report

EXHIBIT 1 - OTM 30 RESPONSE
Expert Panel Final Report

Assessment of the Owens Lake Dust ID and Mitigation Program

This report was prepared jointly by the Expert Panel:

Chat Cowherd, Jack Gillies, and Larry Hagen

May 11, 2010

EXHIBIT 1 - OTM 30 RESPONSE
Expert Panel Final Report

Table of Contents

Assessment of the Owens Lake Dust ID and Mitigation Program

1. Introduction and Background	3
<i>Evolution of Dust Control and Increasing Challenges in Program Completion</i>	<i>3</i>
<i>Role of the Expert Panel</i>	<i>4</i>
<i>Overview of Recent Work in the Expert Panel Process</i>	<i>5</i>
2. Assessment of the Dust ID Program	7
<i>Past Successes and Future Challenges</i>	<i>7</i>
<i>Consistency of Dust ID factors – default vs. event specific</i>	<i>8</i>
3. Ways to Further Tighten the Program—Ambient Monitoring	8
<i>Additional portable shoreline monitors</i>	<i>9</i>
<i>Upwind-Downwind Monitoring</i>	<i>10</i>
4. Ways to Further Tighten the Program—Source Monitoring	12
<i>Redistribution of Sensits and CSCs</i>	<i>12</i>
<i>Portable Measurement Device Applications</i>	<i>14</i>
5. Ways to Further Tighten the Program—Modeling	19
<i>Steps to Improve the Modeling Program</i>	<i>19</i>
<i>Improving Model Applications and K-factors</i>	<i>20</i>
<i>Delineation of Source Areas</i>	<i>23</i>
6. Evaluation of Dust Control Performance	23
7. Development of Study Plans	25
8. Conclusions and Recommendations	26
9. References	29

EXHIBIT 1 - OTM 30 RESPONSE
Expert Panel Final Report

1. Introduction and Background

Evolution of Dust Control and Increasing Challenges in Program Completion

Owens Lake has long been recognized as a major source of fugitive dust generated by high wind events that act on dry lakebed areas. The total lake bed area is 110 mi², but 30 mi² are occupied by a brine pool, and about 35 mi² appears to be naturally stable. Shoreline PM10 monitors have recorded the highest 24-hr PM10 concentrations observed in the U.S. on lands subject to the National Ambient Air Quality Standards (NAAQS).

The Owens Lake dust mitigation program, based in part on the application of the Dust ID model, has been highly successful in reducing dust emissions and the associated shoreline impacts in relation to the NAAQS for PM10. This progress has been confirmed by 24-hr measurements of PM10 concentration across a fixed array of TEOM monitors that qualify as Federal Equivalent Method (FEM) samplers for PM10. The TEOM monitors generate hourly PM10 concentrations at the fixed shoreline locations. It is projected that PM10 emissions from the lakebed have dropped by about 90 percent.

Throughout this process, lakebed areas have been designated for control based on the Dust ID Program, which utilizes hourly dust plume dispersion modeling to link active areas of the lakebed with TEOM monitoring sites that show exceedances of the allowable 24-hr PM10 concentration of 150 µg/m³. Lakebed activity is monitored independently with an array of Sensits and Cox Sand Catchers (CSCs) that in combination provide a measure of hourly sand flux as the dominant driving force for PM10 emissions from the surface.

The Dust ID model is a deterministic model in that it uses available sand flux and wind data to generate predictions of shoreline PM₁₀ concentrations, which are subsequently used to assess how well the control measures are performing and what additional areas are in need of control. It should be recognized however, that the dust emission source is not deterministic, but stochastic in nature with high inherent variability (Shao, 2000), the behavior of which cannot be fully captured by a deterministic model. The Dust ID model, however, was developed on the basis of physical relationships that have been described in the peer-reviewed literature (Gillette et al., 1997a, 1997b, 1997c, 2004; Ono, 2006).

Most of the lakebed areas that have been controlled were evident as major contributors to the dust problem, based on visual observations of dust plumes and surface damage, in addition to monitored sand flux activity. Moreover, in the earlier stages of control implementation, the Dust ID Program was especially effective because of large plume impacts on the TEOM monitoring stations. Although there was significant variability in K-factors, this issue was overridden by the overall evidence of the need to control the identified areas.

EXHIBIT 1 - OTM 30 RESPONSE

Expert Panel Final Report

The area of Owens Dry Lake with installed dust controls has increased from about 10 mi² in 2002, to more than 30 mi² in 2009. Plans are underway to increase the total to 45 mi² in 2012.

The rapid changes in wind erodibility and emissivity, causing large K-factor changes on the lakebed surface, are presently not well understood. There is, however, a general understanding of how different sequences of weather conditions give rise to certain emission characteristics. For example, the phenomenon that precipitates an efflorescent salt crust event, creating the possibility of very high emissions, has a higher probability of occurrence when there is a given sequence of weather conditions. Efflorescence occurs following a wet and cool phase in the winter, causing a salt crust formed at the surface to become soft and powdery and very susceptible to entrainment. In addition, District personnel have recognized other moisture and temperature influences on surface erodibility and emissivity, but these are not quantified in predictive models. Their observational relationships do, however, provide a means to qualitatively assess the emission potential of the lakebed.

Current emission controls that rely on water additions to the lakebed will modify both the hydrology and the humidity of the air in contact with the surface. While unlikely, there is some possibility that parts of the naturally stable areas on the lakebed also could become erodible in the future, which could trigger the necessity for additional controls.

As controls have been implemented and residual emission areas have become less intense and more widely scattered, there has been an increasing challenge to identify additional areas that need control. Although widely scattered areas may be more easily isolated by direct observations of emissions and surface damage, the impacts of these smaller sources on perimeter monitors are much lower and more difficult to attribute to specific source areas through the dispersion model application.

Role of the Expert Panel

The primary role of the technical experts has been to help implement Section 9 of the Settlement Agreement, which recognizes that a method for indentifying sources of potential exceedances of the federal standard at the historic shoreline could be developed that is superior to and could replace or modify the current Dust ID Program. The technical experts were jointly directed by the District and City to provide the following services:

- Review material related to the Dust ID Program and dust control requirements at Owens Lake.
- Participate in technical meetings related to the Dust ID Program and dust control efforts at Owens Lake.

EXHIBIT 1 - OTM 30 RESPONSE
Expert Panel Final Report

- Recommend changes that can be made to the Dust ID Program to improve the method to identify sources of potential exceedances of the federal PM10 standard at Owens Lake.
- Recommend air quality model performance measures that can be applied to the Dust ID model.
- Perform other tasks, as directed, to help carry-out provisions of the Settlement Agreement.

Overview of Recent Work in the Expert Panel Process

The Expert Panel was established to provide an independent assessment of the plans for future controls and their associated technical basis. In 2009, there were three meetings to brief the Expert Panel addressing the technical challenges in completing the remaining phases of Owens Lake dust control so that compliance with PM10 standards around the perimeter of the lake is achieved.

The Experts meeting at LADWP in February 2009 focused on K-factors and model performance, while the meeting at Owens Lake in September 2009 focused on monitoring.

The September meeting began with a demonstration of the PI-SWERL, followed by discussions of the T8 instrument study and additional shoreline monitoring. Other topics included recent delineation maps, the Dust ID modeling schedule and default K-factors. Clearly, all of the important technical issues discussed in these meetings (and in associated teleconferences and email exchanges) directly relate to potential improvements in the Dust ID program, which is the primary tool used to delineate the additional lakebed areas requiring control.

On March 25, 2009, the Expert Panel submitted a report on conclusions and recommendations regarding issues raised at the February meeting. In that submittal, the Experts reiterated the importance of specific items relating to Dust ID program improvements:

- Deploying additional shoreline monitors—portable or fixed, depending on resources available and practicality of relocation in response to forecast wind events
- Modeling with shorter term time increments: 30-min TEOM readings and wind conditions with resolution down to 5 min.
- Continuing the reconfiguration of the Sensit networks with a greater focus on key source areas remaining

EXHIBIT 1 - OTM 30 RESPONSE

Expert Panel Final Report

- Continuing the improvement of source area delineation procedures
- Deploying portable wind erosion simulation devices, e.g., PI-SWERL and portable wind tunnel(s), that might be suitable for localized K-factor determination

Another item that has been listed in recent action items is Upwind/Downwind Monitoring in relation to two areas of application: (a) better isolation of target dust control areas on the lakebed, and (b) evaluation of demonstration-scale dust control measures such as tillage. By measuring much larger plume impacts immediately downwind of a source area, localized upwind/downwind monitoring tends to reduce the uncertainty in Dust ID Program results, in comparison with the results found when much lower lake perimeter impacts must be used as input to the Dust ID Program.

In the area of priorities and timelines for implementation, the Expert Panel expressed concern about confusion that arose in their understanding of the delineation and scheduling of priority actions being undertaken by the City and the District. The Panel requested a system to maintain awareness of the target dates for the major steps in implementing the Dust ID program on an annual basis, although we recognize that this was suggested late in the expert panel process. Nevertheless, it would have been helpful to maintain over the lifetime of this process an accounting of the projected dates of critical communication and information exchanges between the two groups, which would continually have been updated to keep track of how well target dates were being met for specified tasks. This would have aided in understanding the scheduling impacts of additional measures that we or others might recommend to improve the Dust ID Program. An awareness of the priority of concerns and planned actions for both the District and the City would also have helped to decide where the Panel's efforts would have best been focused.

It is clear that these City and District timelines would have been best estimates on the date of preparation, with the expectation that schedules would need to be updated on a regular basis. For example, the timelines would be updated with schedules for new action items coming out of major meetings and teleconferences. It would have been more helpful to the Experts to have had access to the latest version of the timelines as often as was needed.

Overall it is a matter of maximizing the value of information attainable under recognized budget limitations. Available funding must support City and District actions in order of priority. If new approaches are being tested, they must be shown at an early stage to be sufficiently cost-effective to be selected for implementation on a larger scale as part of the Owens Lake Dust ID Program.

EXHIBIT 1 - OTM 30 RESPONSE
Expert Panel Final Report

2. Assessment of the Dust ID Program

Past Successes and Future Challenges

The PM10 emission controls currently installed on Owens Dry Lake are generally highly effective. Most of these controls are based on adding water directly to the lakebed that floods the surface or creates soil moisture content high enough to resist wind erosion. A second successful control measure has been to use irrigation to develop managed vegetation areas, which creates surface cover that protects the lakebed from erosive winds. Many of the controlled areas now provide significant seasonal wildlife habitat. However, it is unclear whether the large annual demands for water from the aqueduct can be maintained or even increased to provide emission controls on additional areas of the lakebed. The combination of substantial maintenance costs coupled with large annual water demands may combine to make a wholly water-based PM10 emission control system unsustainable over the long term at Owens Dry Lake.

Thus, alternative water sources as well as emission control systems that require reduced or no additional water may need to be developed and tested. The current SIP allows the City to test and demonstrate the effectiveness of alternate control measures. However, additional effort is also required to develop a consensus among stakeholders at the lake to allow implementation of alternative PM10 emission controls.

On selected areas, hybrid emission control systems that use vegetation can potentially reduce water use. Incorporation of standing vegetation in the design may have some advantages over flat cover. The silhouette area (side view) of standing vegetation is about five times more effective per unit area in reducing surface shear stress than low-growing cover per unit area (top view). Thus, if 50% flat cover is needed for emission control, only about 10% silhouette area of uniform, standing vegetation is needed, provided that standing height remains about 4 inches or more during high winds (Lyles and Allison, 1976; Hagen, 1996; Bilbro and Fryrear, 1994.)

An important climate feature at Owens Dry Lake is that the high speed winds are consistently funneled by the mountains along northerly and southerly directions (Zhong, et al., 2007). The bi-directional nature of the winds contributes to the effectiveness of dry control systems that can be oriented normal to the wind direction. One example is the moat and row system that was installed as a demonstration project on the lake (Air Sciences Inc., 2000). A few erosive winds are down-slope and thus deviate from their normal directions. Hence, in ridge tillage systems, techniques such as furrow direction changes and furrow blocks should be included in the design to provide saltation control when wind directions are parallel to the ridges.

EXHIBIT 1 - OTM 30 RESPONSE

Expert Panel Final Report

Consistency of Dust ID Factors – default vs. event specific

The Dust ID program uses 75 percentile seasonal K-factors, provided there has been sufficient emission activity and the screening criteria have been met. If the 75 percentile K-factors are not available, then default values are used. Because of fewer exceedances of the 24-hr PM₁₀ standard at the monitoring sites, there has been a greater need to rely on default rather than year-specific seasonal K-factors to estimate emissions. There is now a multiple-year database of K-factors from which to estimate default K-factors. At this time the City and the District have agreed upon the time frame from which these default K-factors can be derived. However, there is still contention over which areas should be assigned individual default K-factors.

Default K-factors are used in the Dust ID prediction model when measured yearly values are not available. The District has proposed using a new set of seasonal default K-factors for various sections of Owens Lake that improves model predictions of daily PM₁₀ emissions compared to the prior default K-factors (Ono and Richmond, 2009). In their study, the District reviewed data on hourly K-factors from January 2001 through June 2009 and selected the most suitable periods for analysis. The computed hourly K-factors were based on the spatial distributions of Sensits and CSC samplers during the analysis period. These hourly K-factors were then used in the model as replacement values for the current default K-factors to evaluate their ability to predict the 24-hour average PM₁₀ concentrations compared to the measured values at Owens Lake from July 1, 2007 through June 30, 2009.

Based on the District analysis, the probability of predicting PM₁₀ shoreline exceedances using these new default K-factors in the Dust ID model was about 50% on days when there were no measured exceedances, as shown in Fig. 6 of the study. Hence, when using default K-factors, one cannot rely on the dust ID model alone to determine if exceedances of the federal PM₁₀ standard had occurred. These results for the Dust ID model were obtained from the CSC/Sensit distribution at that time.

Currently, from a practical standpoint the configuration of Sensits and CSCs is considered to be maximized by the District, and any additional monitoring locations must be requested by the City. It is suggested by the Panel that the option to increase monitoring of sand flux in areas targeted for control be maintained, because better K-factor results can be obtained with a higher density of Sensit/CSCs.

3. Ways to Further Tighten the Program—Ambient Monitoring

The Expert Panel has gone on record in strongly recommending additional monitoring in support of improvements to the Dust ID Program. The Panel recognizes that deploying additional shoreline or upwind/downwind monitors—portable or fixed, depends on resources available and

EXHIBIT 1 - OTM 30 RESPONSE

Expert Panel Final Report

the practicality of relocation in response to forecast wind events or to special studies of specific source areas.

This monitoring is important in meeting the increasing challenges of reliably determining additional lakebed areas to be controlled using the Dust ID approach. Additional PM10 monitoring at shoreline locations offers greater opportunities for significant plume impacts from more widely dispersed source areas. Upwind/downwind monitoring in closer proximity to study areas and control demonstration sites substantially increases the prospects for characterizing these sites with more reliable K-factors and control efficiencies.

If portable TEOMs were plentiful, they would be the method of choice for all monitoring situations, because TEOMs are proven, field-worthy FEM devices that provide “continuous” concentrations resolvable down to 30-min periods. However, the T-8 study has provided sufficient instrument performance data to draw the conclusions about available instrument options other than TEOMs.

The BGI unit when used as a time-integrating FEM PM10 sampler, paired with non-FEM E-Samplers (or DustTraks), provide improved prospects for monitor relocation in response to event-specific wind conditions. This equipment combination also provides approximate hourly PM10 concentrations that are suitable to evaluate the impacts of specific source areas under the Dust ID Program. . This option in turn allows for an evaluation of event-specific K-factors, thus providing a valuable (although not definitive) data set for comparison with the default values.

Even with potential uncertainties raised in determining hourly concentrations with this equipment combination, the potentially larger number of mobile units available would provide valuable near-term information on the most favorable deployment strategy in terms of numbers and spacing of sampling units downwind of a study area. This information could also be of use in ultimately deploying portable TEOMs, once they become available.

Additional Portable Shoreline Monitors

The Panel supports moving forward with the deployment of BGI monitors paired with E-samplers at shoreline locations, which represent (based on a combined best guess) locations where dust plumes that are generated on the lake are most likely to pass. As each dust season progresses, the probability of storm events decreases and the opportunity for measurement of plume concentrations also decreases. However, it is still reasonable to collect measurements during any part of the dust season, as these data add to the currently limited knowledge as to how alternative methods compare on an event-by-event basis with the Dust ID predictions from the TEOM monitoring stations. This can provide critical data needed to evaluate whether the methods are reasonably close (and evaluate the bias), whether they are scaling predictably, or whether they are not at all comparable. The answer to any or all of these questions will be

EXHIBIT 1 - OTM 30 RESPONSE

Expert Panel Final Report

rewarding in that it will allow judgments to be made on the applicability of the methods and what is required to improve each method. Ultimately the results from each method can be used to evaluate whether it benefits the goal of improving the Dust ID program, or whether it should finally be rejected based on evidence of performance.

The Panel recommends that the measured BGI filter mass be apportioned based on the pattern of hourly average concentrations obtained with the E-sampler. Based on the data presented at the meeting in September 2009, we can recognize that reliability in the measurements increases with increasing ambient concentrations and that below some threshold level the information is suspect. Nevertheless, it is critical that the body of evidence be increased to demonstrate that the Dust ID model performs acceptably when challenged by the restricted availability of shoreline data.

When these new data have reached acceptable levels of quality (i.e., when ambient concentrations are sufficiently high), they can be used to produce hourly K-factors. These K-factors will at a minimum provide a means to evaluate (compare and contrast) their distributions with the historical K-factor data set. This would provide significant information to evaluate whether K-factors are changing or remaining relatively stable. It may also help to determine what time frame is most appropriate to resolve “new” default K factors. If the new K-factor data sit quite apart from the historical K-factor distribution, perhaps this indicates that less emphasis should be placed on the older data for characterizing the current situation.

This approach is not, in the Panel’s opinion, an effort without merit even if it does not result in acceptance of the results by both parties. The value of the effort will be in guiding the decision making process, providing data to evaluate against the historical data set, and aid in the future deployment of portable TEOM stations.

Upwind-Downwind Monitoring

Because the PM10 concentration data from the paired BGI/E-Sampler units improve in quality as PM10 levels increase, it may be more beneficial to use these samplers in situations where they are brought closer to the emitting areas. This implies that their use may be suitable for determining emissions in a more focused upwind-downwind arrangement to evaluate emissions and K-factors for specifically identified areas of concern on the lakebed.

A key factor in upwind-downwind monitoring is the development of an instrument deployment strategy that adequately isolates the source area of concern. The evolution of the lakebed surface over time and as a function of changing environmental conditions can create conditions that complicate this undertaking.

EXHIBIT 1 - OTM 30 RESPONSE

Expert Panel Final Report

Samplers that use light-scattering measurements to infer mass concentration (e.g., E-Sampler or DustTrak) cannot be effectively calibrated with Owens Lake dust prior to deployment, because it is impossible to expose these samplers ahead of time to the dust that will impact the samplers. Thus the only assurance of reasonableness of these data will be with the collocation of an FEM BGI sampler, as recommended above.

Whether or not portable samplers are used at shoreline locations or in an upwind-downwind array, performance standard criteria could include:

- Regular monitoring of the flow for an instrument that is awaiting deployment, to ensure that deviations are less than an established percent. (This could be a part of regular quality assurance checks on instrument performance. Flow monitoring could be performed for 30 minutes.),
- Leak checking at the time of deployment,
- Flow measurements just prior to and immediately following the end of sampling, to quantify deviations from the set-point,
- Monitoring baseline drift of the self-calibration between the measurements just prior to and immediately following the end of sampling, to quantify deviations, and
- Taking caution to evaluate temperature effects on the measurements.

The sampler data from upwind-downwind monitoring could be used to evaluate K-factor behavior (i.e., observed range of values), but a decision to use the data for modeling purposes must be held in reserve until confidence in the estimates is established. Confidence in these estimates can be established from the observed behavior of the estimated K-factors in comparison to historical values and to event-specific TEOM-derived values when available.

It would be expected that the K-factors derived from both methods should be linearly correlated. Deviations from the one-to-one line and or a stable scaling relationship will require explanation based on evaluation of the data and the measurement methods. Should the relationship between TEOM/Dust ID and BGI/E-sampler derived K-factors be non-linear (or non-existent), then it will require even greater efforts to uncover the underlying reasons why this could occur. In the latter case (i.e., no relationship), it would seem that there are sufficient sampling problems to warrant rejection of the supplementary method.

EXHIBIT 1 - OTM 30 RESPONSE
Expert Panel Final Report

4. Ways to Further Tighten the Program—Source Monitoring

The desiccation and deterioration of the salt surfaces under proper temperature and moisture regimes at Owens Lake often create initial unstable source areas on the lake bed that emit whenever winds exceed a nominal threshold wind speed. While weak surface crusts are generally stable against wind shear stress, mobile sand-size particles impacting the crusts create point stresses that are orders of magnitude greater than the wind stress. Hence, large amounts of destructive impact energy are imposed on the flat lakebed by the impacting sand during major storms, and that energy rapidly breaks down much of the surface crust and immobile aggregates. While sand moving in an unstable source area destroys crust, it also can destabilize additional downwind areas. The prevailing bi-directional winds at Owens Lake thus can rapidly expand the size of a source area. The expanded source area may then remain unstable for wind storms that occur in the near-future. One may try to roughly define the source area by noting the upwind source boundary and the downwind area where CSC sand catch reduces to a low level compared to the upwind portions of the source area.

In an effort to contain suspected source areas for evaluation they could potentially be isolated by enclosing the area with a number of 1-m-tall ridges created by tillage. To be effective, the tillage ridges need to be composed of about 60% or more immobile aggregates >2 mm diameter. The ridges can serve to temporarily isolate source areas and prevent them from spreading. The volume of sand trapped in the ridge furrows can also be used as an indicator of the areal average sand flux from a given source area (Greeley et al., 1996). Surrounding stable areas with tillage ridges can help to confirm that they are stable and temporarily protect them from upwind sand intrusions.

Redistribution of Sensits and CSCs

The Panel recommends continuing to reconfigure the Sensit/CSC network as conditions on the lakebed change. This provides information on sand activity in areas that are potentially critical source areas. In addition, if the model points to areas that are emitting at levels indicating that control may be necessary, it should be corroborated with Sensit/CSC data. Upon corroboration, repeat the modeling with the new Sensit/CSC data to account for the measured sand fluxes.

The Sensits and CSCs have been used to estimate hourly sediment flux at 15 cm above the surface. The sediment fluxes measured at an instrument location are then used to assign an average sediment flux over groups of gridded cells on the lakebed as inputs for the Dust ID model. The District currently has more than 200 Sensits and CSC's available for redeployment on the lakebed between the controlled and uncontrolled areas that are potential PM10 sources. Minimal monitoring of the controlled areas may be useful to ensure continued performance of the control practices

EXHIBIT 1 - OTM 30 RESPONSE

Expert Panel Final Report

Currently, the district deploys about 16 CSC/Sensits per square mile in critical areas. The Sensits are used to indicate sand flux activity and also partition the temporal variation in the sand flux trapped by the CSC's. At 16 Sensits per square mile, the density of measurements seems adequate to capture the variability in wind speed that drives the saltation process. One can expect that the coefficient of variation (standard deviation/mean) of the (spatial) mean wind speed would be small. However, the coefficient of variation of the mean sand flux could be quite high due to a quite variable sand flux at each point measurement location.

Large spatial variability in the sand flux was observed in data where areal estimates from point CSCs were compared to grids of 9 BSNE samplers during short periods (CH2M Hill, 2002). In later analysis of that data, Ono (2002) found that for 1-2 week periods the sampling error was about 60% when single CSC samples representing 1 km² were compared to 9 BSNE samplers representing the same 1 km². The results were obtained for 4 CSC locations. However, in that study, the long-term CSC sand flux averaged over 4 sites and the BSNE sand flux averaged over 36 sites varied by only about 2%.

In the preceding study, the sparsely sampled, short-term fluxes appeared to deviate considerably from the areal average, but represented the areal average over a long period. These sand flux sampling results help to explain why Q versus Q plots from the dust ID model trend toward following the average between model and measured results, because the Q versus Q plots match only the magnitude of the emissions over time and not the time of occurrence. In contrast, there is typically large scatter in the measured versus predicted model concentration values for individual emission events.

In the more recent moat and row demonstration study (Air Sciences Inc., 2008), the CSC cumulative samples collected at 40 m intervals along transects in the areas not sheltered by the row structures also exhibit considerable scatter with an average coefficient of variability of 0.43. Because the scale of the emissive areas on the lakebed has been reduced, both the temporal and spatial variability of the sediment fluxes are likely to increase, which also impacts model uncertainties.

These data show that the potential error in the areal average sediment flux estimated from an individual point sample is very large, particularly in areas where the crust has been partially destroyed. Hence in uncontrolled source areas, the Panel recommends installing two additional CSCs near each Sensit spaced at a distance of 50 m on either side at along a line oriented at a 45-degree angle to the prevailing bidirectional erosive wind directions. Orienting at 45 degrees will enhance the probability of detecting local gradients in catch along and normal to the wind direction.

EXHIBIT 1 - OTM 30 RESPONSE

Expert Panel Final Report

When substantial mobile sediment is trapped by the CSCs over a significant area during single events, the sediment source, whether local or far upwind, needs to be identified. Thus, even when used alone, the CSC data provide significant information for possible control measures.

Currently, areal assignments of sand flux are made to polygons from point measurements obtained from individual CSC samplers. These estimates may be resolved down to 5 minute intervals using impact data from Sensit instruments. Boundaries of the emissive areas are estimated using a range of methodologies including GPS. Once established, however, the boundaries may be used for calculating emissions from individual storms. The grid cells used in the CALPUFF model are assigned emission values based on the polygon sand fluxes and a K-factor. The current procedures result in step changes in sand flux among the polygons and generally ignore sand flux gradients near the boundaries.

In prior research, significant gradients in sand flux have been observed near the boundaries with non-emissive areas (Hardebeck et al., 1996). Steep gradients in sand flux were also recently measured near boundaries in the vicinity of the Moat & Row structures (Air Sciences Inc., 2008).

Typically, gradients of increasing sand flux occur downwind from the boundary with an upwind stable surface. Similarly, one may expect a decreasing sand flux approaching a downwind stable area, unless the downwind boundary is created by an abrupt sand trap such as a water body. As control measures are implemented on the lake bed, the emissive areas are decreasing in size. As a consequence, when the ratio of circumference to total area of an emissive area increases, so does the influence on emissions of the sand flux gradients associated with the non-eroding boundaries.

Block kriging of the sand flux for individual storms may provide a method to account for the relative boundary gradient effects on various grid cells in the emitting area (Bhattai, et al., 1991; Mazzetti and Todini, 2002). The addition of the recommended CSC samplers should provide additional data to facilitate choosing appropriate variograms. The relative relationships among the cells developed by kriging could then be applied to short-term flux estimates. Where interior boundaries within an emitting area are deemed important, one may add additional constraints to the block kriging algorithm.

Portable Measurement Device Applications

The PI-SWERL or other portable emission measurement devices offer a means to evaluate source area emission potential variations both spatially and temporally. These devices provide essentially point measurements of PM10 emission potential of a surface, which if taken in sufficient coverage can provide a reasonable estimate of the mean and variance of this surface property for the environmental conditions under which the tests are made. Because the PI-

EXHIBIT 1 - OTM 30 RESPONSE

Expert Panel Final Report

SWERL and small portable wind tunnels often have limited sand flow conditions, it is recognized that the abrasion of immobile clods and crusts in these devices is also limited. Hence, they may be most useful (a) on surfaces composed of all mobile soils with unlimited PM10 supply or (b) on erodible areas that receive little incoming sand and are expected to have a limited PM10 supply. Otherwise, either type of unit can be used to measure the relative PM10 wind erosion potential of the surface under somewhat limited sand flow conditions.

The question of equivalency of alternate methods to recognized reference methods is at issue. In the development of source measurement methods, it is customary to follow a 3-stage process:

1. Pilot scale tests—proof of concept under controlled conditions in field or laboratory, typically on reduced-scale source
2. Demonstration tests—conducted at one or more full scale test sites
3. Implementation—conducted at multiple full scale test sites as required

In general *in situ* source monitoring methods may be categorized into three sampler configuration categories. The first category is linear flow devices such as conventional wind tunnels. Portable wind tunnels of different scales have already been deployed at Owens Lake. The second category is swirling flow devices such as the PI-SWERL, which are much more compact and easier to deploy. However, for swirling flow devices an issue arises as to the comparability of the lift-off forces of swirling flow as compared to linear flow. The third category of air blast devices features even greater compactness and ease of use. Once again, however, there is a comparability issue regarding the representativeness of an air jet impinging on the surface.

The overriding issue in assessing the usefulness of *in situ* source measurement methods is performance comparability. Once again there are three levels to be considered. The most desirable objective is to establish that the performance of the proposed method is equivalent to an accepted reference method for measurement of sand flux and PM10 emissions. In essence, performance equivalency must be demonstrated by deriving a linear calibration factor between the proposed method and the accepted method, normally having the same operating principle.

The next level involves scalable measurements of sand flux and PM10 emissions. In this case, it is necessary to establish acceptable equivalency (as above) using a non-linear calibration factor. The non-linearity reflects the fact that the principles of operation between the proposed method and the reference method are similar but not identical.

EXHIBIT 1 - OTM 30 RESPONSE

Expert Panel Final Report

Finally, screening measurements of sand flux and/or PM10 emissions can be based on a device with a substantially different operating principle. In this case the measurement results must be shown to be relevant to results obtained with reference or scalable measurement methods.

Collocation of all methods being compared is recommended, with sites to be selected based on a range of representative surface conditions. If test sites can be selected at locations outside of Owens Lake with the goal of compiling a significantly larger performance database for comparison, based on a given level of resource investment, it is acceptable to perform the comparability tests at such sites. However, it must be established that the soil characteristics are reasonably representative of the more emissive surface conditions that drive the PM10 emission processes at Owens Lake.

The uses of alternative *in situ* measurements relate to the performance comparability level that is established. Equivalent reference methods offer good possibilities for independent K-factor determination. Scalable methods offer less robust platforms for independent K-factor determination, but may provide useful information on relative K-factor variability. Screening methods are useful for approximate delineation of source area boundaries and internal hot spots. All methods require pre-tests of source emission variability within given source areas to set the foundation for layout of sampling points.

One other application that could be considered is to evaluate whether an area identified as a potential candidate for remediation does have emission levels that support this identification. This evaluation could be based on comparison with a data set that consists of measurements from a surface known to have emissions below levels that create the possibility for shoreline exceedances.

Use of the PI-SWERL (or other emission measurement devices) will require that the PM10 measurement device (e.g., DustTrak) be calibrated against a mass-based standard to some agreed upon level for the measurements to be acceptable. One suggestion is that this be accomplished using laboratory based re-suspension techniques that allow for a comparison between DustTrak measured average concentrations of PM10 and gravimetric mass average concentrations so that a scaling relationship between the methods can be established. This could be done based on the sampling plan, specifying that for each defined area where a series of DustTrak measurements are taken, a composite sample of surface material is also collected. This bulk surface sample would be returned to the lab, sieved to collect particles <34 μm , which in turn are mechanically re-suspended in a chamber that allows samples to be withdrawn for emplacement on filters.

The sieving of the material through a 34 μm sieve removes the sand and coarse silt from the bulk sample and concentrates the particle sizes of interest (i.e., PM10) into a sub-sample. This facilitates the ease of suspending these particles in a mixing chamber from which the dust-laden

EXHIBIT 1 - OTM 30 RESPONSE

Expert Panel Final Report

air is directed into the plenum connected to the flow-controlled filter packs that collect the samples for gravimetric analysis. These filters are used to calculate mass concentration, which can then be compared with the average DustTrak values. Each comparison involves a significant effort (one person day per sample).

This follows the methodology originally presented by Chow et al. (1994) and modified by Gillies et al. (2010) and Kuhns et al. (2010). Caravacho et al. (2004) found that the ratio of PM_{2.5} to PM₁₀ produced by resuspension methods is similar to field observations of the same ratio for ambient concentrations downwind of agricultural operations in the San Joaquin Valley of California, suggesting that this approach provides a good approximation of the PM distribution of *in situ* dust emissions.

An example of a DustTrak PM₁₀ versus gravimetrically determined PM₁₀ is shown in Fig. 1. This relationship was used by Kuhns et al. (2010) to convert DustTrak measured PM₁₀ to gravimetric equivalent values used in developing emission factors for wheeled and tracked vehicles on unpaved roads. This relationship has been observed to change based on the source material, but this is expected because the actual particle size distribution of the emitted PM₁₀ (particulate matter $\leq 10 \mu\text{m}$ aerodynamic diameter) and its optical properties will be to a certain degree site specific.

Another method to determine the relationship between the light-scattering-derived PM₁₀ and gravimetrically-determined PM₁₀ could be based on *in situ* measurements of PM₁₀ using filter sampling of the dust within the PI-SWERL. This method has not been tried nor verified, so it would require some evaluation and likely re-configuration of the PI-SWERL. The basic idea would be to relate the integrated mass concentration of PM₁₀ measured by the DustTrak to the mass collected on filters sampling the same dust-laden airstream as the DustTrak. This could be done during a sampling test, or it may require a specific calibration test at the same site as the PI-SWERL test locations. Additional testing to evaluate whether the particle size distribution changes during testing with PI-SWERL could be carried out using available particle sizing technology. However, data are lacking as well on the evolution of particle size distributions during on-lake dust emission events.

The City has expressed a keen interest in evaluating the plausibility of using *in situ* techniques (PI-SWERL or wind tunnels) to determine absolute K-factors or emission rates as a replacement for and as a check on Dust ID generated default K-factors. It is difficult to define performance and measurement standards required to give a high confidence that the ratio of dust emission flux to sand flux obtained from an *in situ* measurement device represents the value derived from direct measurements during an actual dust emission and sand transport event. The complicating issues relate to scale and to the impossibility of maintaining dynamic and kinematic similitude between the instrument and the natural process. The best one can hope for is to prove that a

EXHIBIT 1 - OTM 30 RESPONSE

Expert Panel Final Report

linear relationship exists between the natural and the simulated process, as this indicates that the basic physics of the emission process in the instrument is closely linked to the physics of the unconstrained natural process. A second difficulty in the case of Owens Lake is that the Dust ID K-factor is itself derived by a combination of modeling and measurements. K-factors are determined based on (a) measurements of horizontal sand flux on the lakebed and shoreline measurements of PM10 and (b) the model assumption that PM10 emissions are proportional to the horizontal sand transport across the source area. The direct measurement of a K-factor that represents the actual case is non-trivial in itself, and the options for measurement as well as an appropriate methodology are still a matter for debate.

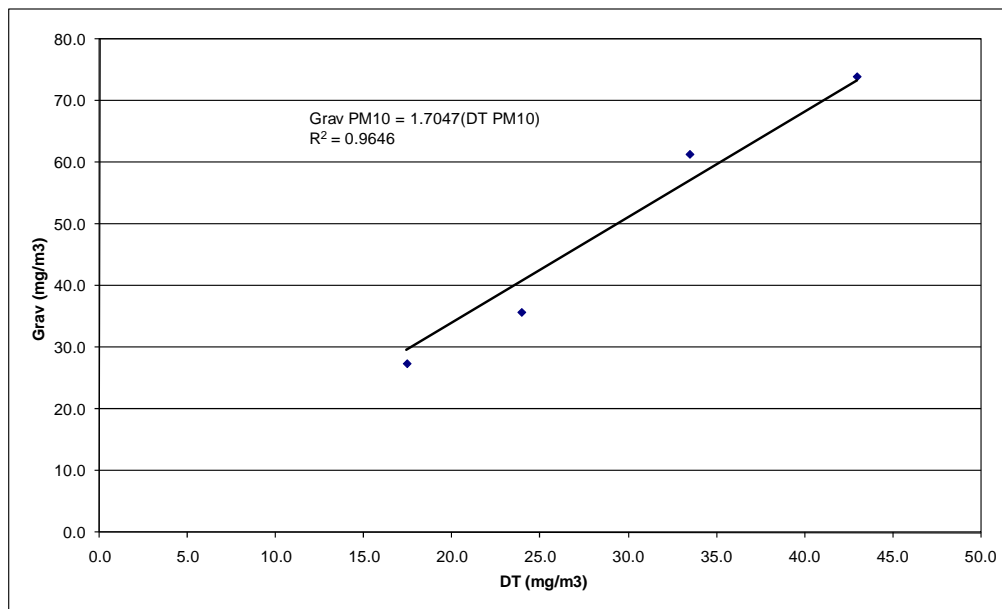

Figure 1. The relationship between DustTrak PM10 and gravimetrically determined PM10 for resuspended unpaved road materials removed from Ft. Carson, CO, as determined from resuspension chamber measurements (unpublished data)

Once again, just gaining field experience with these types of units will provide valuable information on such factors as ease of deployment, the rate at which testing can be performed, and the usefulness of the devices for delineation of source area boundaries and emission potential variations within a source area.

EXHIBIT 1 - OTM 30 RESPONSE
Expert Panel Final Report

5. Ways to Further Tighten the Program—Modeling

Steps to Improve the Modeling Program

The Panel has recommended several steps to improve the modeling program. This begins with shortening of the time averaging period. Model runs have recently been performed using 30-minute TEOM data and 5-minute data for wind conditions and for Sensit activity. Using 5-minute wind data should improve the estimates of plume dispersion, particularly for source areas far from the shoreline monitors. In addition, examining the 5-minute plume data may help to identify cases where the plume was bypassing the PM10 sampler during a portion of the 30-minute sampling period.

Another step recommended by the Panel is analysis of factors that might explain K-factor variations. This would include

- plume edge effects,
- improper source area delineation,
- hotspot contributions within a source area,
- differences in surface characteristics within a source area,
- the time cycle of the emission process resulting from wind shifts and surface process evolution, and
- resuspension of deposition from earlier wind events.

Some of these factors may prove difficult to quantify, but should be considered. Simple modeling experiments can be performed to determine the sensitivity of the K-factor to each of the above factors. This would provide valuable information in understanding the workings of the Dust ID model.

A possible issue with 5-minute modeling relates to differences between the modeled plume arrival at the sampler and the true arrival time. Currently, additional modeled receptor points in the vicinity of the sampler may be examined to determine if they improve the match to the modeled concentration. Another approach would be to calculate a 30-minute moving average of the 5-minute modeled data and then determine the best match to the 30-minute measured sampler data.

The cameras surrounding the lake may provide some evidence for resuspension of dust from normally stable lake bed areas. Sieving of the CSC catch in such areas, if available, should also confirm that the bulk of the moving material was <100 μm in diameter.

EXHIBIT 1 - OTM 30 RESPONSE

Expert Panel Final Report

Surface conditions immediately downwind from an emitting surface may result in various levels of deposition from a surface-initiated plume. Measurements from a 180 m diameter agricultural source area showed that a major fraction of PM₁₀ deposition from the plume occurred within about 200 m of the source boundary over a downwind vegetated surface (Hagen, et al. 2007).

The presence of a wet, wavy surface immediately downwind of a surface-source plume may also significantly enhance deposition from a plume compared to a dry smooth area (Zufall et al., 1999.) Hence, it may be useful to adjust CALPUFF deposition values based on the form of deposition surface immediately downwind of the various source areas at Owens Lake

Improving Model Applications and K-Factors

Earlier we provided some discussion how measurements could be used to aid in the improvement of K-factor robustness. In this section we discuss model based analysis to provide a means to potentially improve K-factor estimates.

The basic assumption for using the K-factor the in the Dust ID program is that

$$f = \text{K-factor} \times q$$

where f ($\text{g cm}^{-2} \text{ hr}^{-1}$) is the vertical PM₁₀ flux, q ($\text{g cm}^{-2} \text{ hr}^{-1}$) is the horizontal saltation flux measured at 15 cm above the surface and K-factor is the proportionality constant (dimensionless).

Unfortunately, it is difficult to measure a K-factor directly over multiple large areas. Hence, the methodology used to estimate K-factor in the Dust ID program has been to first employ the CALPUFF dispersion model to estimate shoreline PM₁₀ concentrations using measurements of q and wind speeds on the lakebed and then to back-calculate K-factor values that force agreement between modeled and measured PM₁₀ concentrations.

Using the preceding methodology to estimate K-factor values results in a large variance in K-factor estimates that may range from 1×10^{-5} to 100×10^{-5} or more, within single or closely-spaced emission events. In addition, most emissive areas on the lakebed are now controlled, so the dust plumes typically pass between shoreline monitors during much of their life cycle so only a few or no K-factors can be based on measured PM₁₀ concentrations. Even when improved default K-factors are used, the modeled versus measured results on a 24-hour basis have an overall linear correlation of about 0.40 (Ono and Richmond, 2009).

There are at least two possible improvements for the above problem that could be implemented. First, employ the CALPUFF model along with past wind storms and current emissive areas on the lakebed to estimate the probability of measured PM₁₀ exceedances of the federal standards

EXHIBIT 1 - OTM 30 RESPONSE

Expert Panel Final Report

along the lakeshore during each season. At points where probabilities of exceedances are highest but unmeasured, place additional shoreline samplers.

A variation on this approach is to input likely wind scenarios into CALPUFF based on weather forecasts and then move portable PM₁₀ monitors to the most likely exceedance locations. This application of CALPUFF depends mainly on good plume simulations, but not on accurate K-factors.

Some general correlations between K-factors and other variables have been reported. For example, the K-factor increased as the measured TEOM PM₁₀ concentrations increased. There was also a tendency for on-lake TEOMs to result in higher 75th percentile K-factors. In contrast, K-factor decreased as Q_i/D_i increased, where Q_i and D_i are sum of CSC sediment catch and distance to the TEOM sampler, respectively, during the i^{th} emission period (Air Sciences, 2008).

Variations in the K-factors with distance may be caused by errors in diffusion and deposition estimates and/or impacts of multiple sources on a TEOM. Hence, a second approach toward improving estimates of K-factors is to assume that a significant portion of the large deviations in short term K-factors are caused by the surface conditions in the emitting areas coupled with the wind conditions that transport the flux to the shoreline monitors and the intervening deposition surfaces. Currently, a large amount of periodic information related to both the soil surface and winds is collected for each emission event, but not used to refine estimates of default K-factors during the emission event.

To develop a predictive tool for K-factors, various parameters might be entered into a stepwise regression analysis using linear and curvilinear forms as independent variables along with measured K-factor as the dependant variable. Some possible candidates for independent variables include:

Q_i/A_i ~ related to average sediment flux, where Q_i is horizontal flux at 15 cm in the upwind PM₁₀ emitting area A_i that is impacting the TEOM during i^{th} time period.

A_i ~ related to scale of the emission area impacting TEOM in i^{th} period.

D_i/U_i ~ related to PM₁₀ deposition and diffusion time, where D_i is distance to emitting surface and U_i is a representative wind speed.

Q_i/ U_i ~ related to PM₁₀ concentration.

U_{ti} ~ related to wind speed threshold velocity.

$Q_i/ [U_i^2 (U_i - U_{ti})]$ ~ related to horizontal flux at 15 cm relative to transport capacity.

EXHIBIT 1 - OTM 30 RESPONSE

Expert Panel Final Report

$\sum^{t-1}(Q_i/A_i) \sim$ related to cumulative average of all prior period horizontal fluxes for storm.

SF_{sand} ~ soil fraction sand in surface two centimeters.

SF_{clay} ~ soil fraction clay in surface two centimeters.

The first three variables are related to the i^{th} period emission event; the next four variables are related to the surface conditions; and the last two variables are slowly varying intrinsic surface properties.

Past observations on the lakebed have increased the understanding of precipitation and temperature effects on the surface emission potential. It would be useful to quantify this knowledge for application to K-factor predictions. Hence, additional independent regression variables representing temperature, precipitation, humidity, and surface wetness effects should also be developed based on the knowledge developed by those experienced with the lake bed cycles.

The regressions for predicted K-factors will need to be developed from data points when individual or similar source areas are impacting a PM10 sampler. Once developed, predicted K-factors then can be assigned temporally to the various source areas as they evolve. The District recently developed updated default K-factors (Ono and Richmond, 2009), but these have not yet been accepted by the LADWP. The regression approach suggested in the preceding section may serve as another alternative to develop a new temporal or default K factors. In the Panel's opinion, the lakebed emission sources have changed in terms of their areal extent so that the original default K factors likely do not represent the right proportion of source types that now characterize the emissive surfaces on the lakebed.

Until the decision to adopt new default K-factors is accepted, it is recommended to proceed with parallel evaluations using the original K-factors and new default values, which may change as data are evaluated or specific time intervals are decided upon on which to base K-factor values. Having the ability to evaluate a comparison that uses different K-factors may add insight into the changing emission system.

There is a need to evaluate any improvements in K-factor predictions. In general, entirely separate data sets for model development of K-factors and model validation are not generally available at Owens Lake. A partial solution to this problem is to use a statistical technique such as k-fold cross-validation that employs all observations in the data set both as part of the model training set and also as part of the validation set. In the test sequence, all observations except a single validation subset are used to develop the model. This process is then repeated until all subsets have been used as validation subsets. The mean squared error or other statistical

EXHIBIT 1 - OTM 30 RESPONSE

Expert Panel Final Report

measures can then be used to summarize the prediction errors of the validation subsets ([http://en.wikipedia.org/wiki/cross-validation_\(statistics\)](http://en.wikipedia.org/wiki/cross-validation_(statistics))).

The assignment of default K-factors to specific areas of the lakebed is under consideration for revision by the District. There are currently three designated areas: the South, Central, and North. The District has proposed new default K-factor areas they identify as the “Keeler Area” and “Managed Vegetation Area”, which have become separated from the North and South Areas, respectively. The Keeler Dunes and Central Area are designated at this time to remain as defined by their current boundaries. The District Memorandum of 12-03-2009 describes the methodology for developing new default K-factors, and states that there is general agreement with the City on this procedure. What is unclear in the District memorandum is the method or rationale used to separate these newly-defined areas, which should be made clear with justification provided for review.

Delineation of Source Areas

The current methods for delineating source areas include: on-lake reconnaissance and GPS mapping of observer-defined boundaries following storm events, shoreline mapping of identified plume source areas, and video surveillance to identify source areas. Over the last three years, the City’s consultant (Newfields) and the District have collaborated to standardize the methods for identifying source boundaries, which was a very positive development. The Expert Panel encourages the pursuit of methods to refine source area delineation as it plays an important role in the quality of the Dust ID predictions.

6. Evaluation of Dust Control Performance

Evaluation of the control efficiency of a dust control measure, especially at the scale of implementation it may occur on Owens Lake, is a challenging undertaking. This kind of exercise typically involves referencing the emissions post treatment to those that were present pre-treatment, or alternatively the emission data are compared between treated versus untreated areas to determine the ratio of emissions of controlled to emissions from uncontrolled surfaces. This ratio effectively describes the reduction efficiency of the control measure as compared to the uncontrolled conditions that are causing the emissions. This can be developed from emission measurements during an actual wind event, or the ratio can be based on a simulation measurement device that can be applied nearly simultaneously to both the treated and untreated surfaces. This later approach is typically used to evaluate dust suppressant efficiency (e.g., Gillies et al., 1999; Kavouras et al., 2009). An acceptance criterion needs to be established to determine whether the performance of the control measure is deemed sufficient. The current acceptability for a control measure used on the lakebed is set at a very high standard of 99%.

EXHIBIT 1 - OTM 30 RESPONSE

Expert Panel Final Report

At Owens Lake, there are several options of evaluating effectiveness of a control measure. The first involves measurement of dust emission reduction using an upwind-downwind sampling method to estimate how the emissions are changed between the upwind and downwind edges of the controlled area. This is made difficult at Owens Lake because the controlled area is often embedded within a large area source that can result in high area PM₁₀ concentrations, making it a greater challenge to determine the precision at which the delta difference in concentration is discernible by the instrumentation.

A second approach is to rely on a measurement of saltation reduction to infer a reduction in dust emissions. In this case, sand flux changes between the upwind and downwind edges of the controlled area would define the effectiveness ratio between controlled and uncontrolled areas located in close proximity to each other. The reduction in PM₁₀ is then presumed to be proportional to the reduction in sand flux. This method offers a more cost-effective means to evaluate effectiveness, as it involves the use of passive measurements such as traps, which could be at-a-point types such as the CSC.

Alternatively, more bulk measurements of sand movement could be estimated from material that falls into a large trench at the downwind edge of paired controlled and uncontrolled areas. In effect, the ratio of trapped sand in the downwind trench of the controlled area compared to the uncontrolled area defines the emission reduction ratio. This assumes that the sizes of the trench (or size of a sub-portion) for both the controlled and uncontrolled areas are equal. This approach allows for a sample that integrates the variability in the saltation flux as a function of horizontal distance perpendicular to the direction of transport. Spatial variability of horizontal saltation will be more difficult to account for using at-a-point traps, unless a large number of traps are used.

The overall goal of the control measures is to achieve air quality compliance at the shoreline monitors. Hence, it is possible that control methods with less than 99% efficiency can reduce PM₁₀ levels at the shoreline down to or even below the required limits. Consider that the surface of Owens Lake is not a homogeneous emitter of PM₁₀ in any defined area. This spatial variability of dust emissions in any area is recognized, but not quantified. If the emissions for the surface were quantified on some spatial scale, it is likely that the distribution of emissions would be normal or perhaps log-normal. Hence, a control measure applied across a large area would reduce the magnitude of the emissions differently across the area. If the high emitting areas have less areal extent than lower emitting areas, then even at less than 99% efficiency, shoreline levels could fall below the target values.

EXHIBIT 1 - OTM 30 RESPONSE
Expert Panel Final Report

7. Development of Study Plans

The success of any of the above items requires the development of planning documents that carefully address implementation issues ranging from equipment deployment to data analysis. These plans should have a reasonable level of consistency in terms of content and format, for ease of preparation, review and cross-comparison.

According to 2009 action items, several plans were scheduled in preparation by the City and the District, but it appeared to the Panel that there was some confusion as to when these were made available for review. Plans were to be prepared for (a) upwind/downwind monitoring, (b) re-deployment of Sensits, (c) alternative uses of the PI-SWERL, (d) 5-min. modeling, and (e) operation of portable shoreline monitors. An action item status table updated periodically would be helpful to clarify this situation. If the plans have been completed, this notification system would make it obvious to the interested parties.

As appropriate, the plans should include data compilation and reduction steps with example calculations of test results. If a particular special study is being proposed, the planning document should clearly state the objectives of the study and define the experimental design and procedures to be used. The Panel requested that planning documents be posted for review by the Panel and others at an early stage as technical approaches to each problem are developed and refined. In addition, there has been some level of confusion about the availability of standard operating procedures for each type of monitor that has been used at Owens Lake. Even the standard procedures associated with the basic Dust ID Program tend to be imbedded in larger documents rather than made available separately.

The Panel recommended a centrally organized electronic filing system as an effective tool in clearly presenting the procedures for all to review as needed. In our opinion, one of the more essential roles of the Experts has been to promote this documentation system and to review and comment on new plans as they are developed, so that any ambiguity is removed in deciding exactly how the various devices and methods are to be used. The Panel appreciates the District's efforts to reorganize information on the ftp site.

Partially in response to these recommendations by the Panel, several plans and procedures developed by the District and the City have been posted on the District's ftp site. The Panel views this as a continuing positive factor in promoting communication and understanding of research and assessment studies being performed to maintain and even strengthen the program to achieve the remaining lakebed emission reductions needed to meet the compliance objectives.

The Panel also recommends continuation of regular meetings of the City and the District, to review the status of the dust control efforts and progress made in achieving program objectives.

EXHIBIT 1 - OTM 30 RESPONSE
Expert Panel Final Report

This would include meetings associated with the annual cycle for implementation of the Dust ID program.

8. Conclusions and Recommendations

Based on a review of documents and presentations by the District and the City and subsequent deliberations, the Expert Panel has reached a number of key conclusions and recommendations relative to the technical issues discussed and the investigative strategies developed to meet the objectives of the Owens Lake dust control program. These are summarized below:

1. While impressive progress has been made in reducing the dust emission impacts of Owens Lake and in moving toward PM10 compliance along the shoreline, the completion of the process is equally as challenging. The Panel encourages ongoing exploration of steps that would refine the Dust ID program to accomplish compliance objectives as cost-effectively as feasible.
2. The Panel recommends sensitivity analyses of the elements of the Dust ID program as the basis for determining what refinements in monitoring (source and ambient) and modeling have the greatest promise for achieving program improvements. Necessarily, the complex phenomena associated with wind-driven dust emissivity of the lakebed have required simplification in monitoring and modeling aspects of the program, and we suggest that hypothetical modeling runs would provide valuable information as to the relative level of refinement with which each aspect should be represented for the best overall result.
3. The Panel encourages development of alternative field methods, even though they do not match reference methods in performance, if such alternative methods can be used to support screening studies that provide useful information for refining the monitoring and modeling aspects of the Dust ID Program.
4. The Panel recommends continuing to increase the number of shoreline monitors and to improve the number of available K-factors as well as to validate model predictions of exceedances. The latter will become increasingly important as the lakebed stabilization efforts approach compliance with the air quality targets.
5. Because the large spatial variability of the saltation flux over the source areas appears to be a significant problem in developing accurate model inputs, the Panel recommends adding two additional CSC in the vicinity of each Sensit site in critical areas, to improve confidence in the flux measurements and discern local gradients. Applying block kriging to the catches from each significant whole storm should improve estimates of the relative

EXHIBIT 1 - OTM 30 RESPONSE
Expert Panel Final Report

contributions from each model grid cell and account for flux gradients, particularly in vicinity of the non-erodible boundaries. On some soils, it also may be feasible to temporarily isolate and better define source and non-source areas by surrounding them with a series of large tillage ridges

6. The Panel recommends continuing to test several possible improvements for application of the CALPUFF diffusion model. These include using 5-minute wind and CSC catch data and 30-minute TEOM data to improve representation of dust dispersion and to provide additional K-factors. The model deposition rate should also be adjusted for the type of surface (i.e., re-suspending, dry, vegetated or wet) immediately downwind of various surface source areas.
7. The calculated K-factors at Owens Lake exhibit an extremely wide range over relatively short time periods. If implementation of the preceding recommendations does not reduce the short-term variability, one may conclude that the variability is caused by the storm characteristics and surface conditions. Hence, one should be able to develop regression equations to predict variable K-factors based on storm and surface conditions rather regard them as fixed values at the 75-percentile of a random distribution.
8. As new K-factors are developed, their ability to improve the Dust ID model should be assessed using a k-fold cross-validation or other suitable statistical tests along with statistical measures to summarize the prediction errors. The Panel sees an advantage in maintaining separate sets of K-factors proposed for potential consideration, and in periodically cross comparing these factors to assess which set performs best.
9. The Panel recommends continuation of an active information exchange between the District and the City and the maintaining of a well-organized library of documents and presentations on the District's ftp site. This should include planning and execution documents for any new research studies that are performed.

The Panel would also like to state that during the process of our involvement in the Owens Lake dust control program, we observed that air quality improvements along the historic shoreline of Owens Lake are limited by factors beyond the technological and implementation challenges to dust control. There are also barriers that appear to be institutional or constrained by the legal constructs of the settlement agreement. An example of the latter is the very high dust control efficiency of 99%, which from an engineering perspective, may be unattainable for mitigative measures that do not involve saturation of the surface with water. This could lead to rejection of perhaps some very good control methods that, if adopted, could provide control at a level that would clearly limit dust production sufficiently to meet overall air quality compliance objectives.

EXHIBIT 1 - OTM 30 RESPONSE
Expert Panel Final Report

Nevertheless, we encourage further testing of dry dust control measures at Lake Owens. Local upwind/downwind monitoring may be particularly useful to evaluate their dust control capabilities.

There are also challenges to mitigating the dust emissions from the lakebed that are linked to the various stakeholders (including landowners or those that exert control over portions of the lakebed) within the state of California. Although outside the purview of the Expert Panel, it has been apparent that these outside influences have had an effect on the execution of the dust mitigation strategies that have been both undertaken and proposed for Owens Lake.

The Expert Panel commends the District and the City for their efforts in making great strides to achieve the over-arching goal of reducing PM10 emissions from Owens Lake so that shoreline compliance objectives are met. Further, we trust that both groups will continue to work together in the same manner as has been observed by the Panel, to complete this laudable goal.

EXHIBIT 1 - OTM 30 RESPONSE
Expert Panel Final Report

9. References

- Air Sciences Inc, 2000. Final Moat and Row demonstration project control efficiency report. Los Angeles Department of Water and Power Project No. 228-2.
- Air Sciences Inc., 2008. Influence of distance from source to TEOM k_v2-1.pdf.
- Bhattai, A.U., D.J. Mulla, B. Frazier, 1991. Estimation of soil properties and wheat yields on complex eroded hills using geostatistics and thematic mapper images. *Remote Sensing of Environment* 37(3): 181-191.
- Bilbro, J.D. and D.W. Fryrear, 1994. Wind erosion losses as related to plant silhouette and soil cover. *Agronomy Journal* 86:5 50-553.
- Carvacho, O.F., L.L. Ashbaugh, M.S. Brown, and R.G. Flocchini, 2004. Measurement of PM2.5 emission potential from soil using the UC Davis resuspension test chamber. *Geomorphology* 59: 75-80.
- CH2M Hill 2002. Comparative sand flux measurements using BSNE and Cox sand catchers on south sand sheet of Owens Dry Lake: CSC v BSNE. South sand project 2002-1.pdf.
- Chow, J.C., J.G. Watson, J.E. Houck, and L.C. Pritchett, 1994. A laboratory resuspension chamber to measure fugitive dust size distributions and chemical compositions. *Atmospheric Environment* 28: 3463-3481.
- Comparative sand flux measurements using BSNE and Cox sand catchers on south sand sheet of Owens Dry Lake. CSC v BSNE (CH2M Hill South sand project 2002)-1.pdf.)
- Cox, B. Jr., G.M. Holder, 1997. Owens Lake Aeolian Report. Great Basin Unified Air Pollution Control District, 157 Short Street, Bishop, CA.
- Gillies, J. A., V. Etyemezian, H. Kuhns, J.D. McAlpine, S. Uppapalli, G. Nikolich, and J. Engelbrecht, 2010. Dust emissions created by low-level rotary-winged aircraft flight over desert surfaces. *Atmospheric Environment* 44: 1043-1053
- Gillies, J.A., J.G. Watson, C.F. Rogers, D. DuBois, D., J.C. Chow, 1999. Long-term efficiencies of dust suppressants to reduce PM10 emissions from unpaved roads. *Journal of the Air & Waste Management Association*, 49: 3-16.

EXHIBIT 1 - OTM 30 RESPONSE
Expert Panel Final Report

- Gillette, D., Ono, D., and Richmond, K., 2004. A combined modeling and measurement technique for estimating windblown dust emissions at Owens (dry) Lake, California. *Journal of Geophysical Research-Earth Surface* 109.
- Gillette, D. A., Fryrear, D. W., Gill, T. E., Ley, T., Cahill, T. A., and Gearhart, E. A., 1997a. Relation of vertical flux of particles smaller than 10 μm to total aeolian horizontal mass flux at Owens Lake. *Journal of Geophysical Research* 102, 26,009-26,015.
- Gillette, D. A., Fryrear, D. W., Xiao, J., Stockton, P., Ono, D., Helm, P. J., Gill, T. E., and Ley, T., 1997b. Large-scale variability in wind erosion mass flux rates at Owens Lake 1. Vertical profiles of horizontal mass fluxes of wind-eroded particles with diameter greater than 50 μm . *Journal of Geophysical Research* 102, 25977-25987.
- Gillette, D. A., Hardebeck, E., and Parker, J., 1997c. Large-scale variability of wind erosion mass flux rates at Owens Lake 2. Role of roughness change, particle limitation, change of threshold friction velocity and the Owen effect. *Journal of Geophysical Research* 102, 25,989-25,998.
- Greeley, R., D.G. Blumberg, S.H. Williams, 1996. Field measurements of the flux speed of wind-blown sand. *Sedimentology* 43(1): 41-52.
- Hagen, L.J., 1996. Crop residue effects on aerodynamic processes and wind erosion. *Theoretical and Applied Climatology* 54: 39-46.
- Hagen, L.J., S. Van Pelt, T.M. Zobeck, and A. Retta, 2007. Dust deposition near an eroding source field. *Earth Surface Processes and Landforms* 32(2): 281-289.
- Hardebeck, E., G.Holder, D. Ono, J. Parker, T.D. Schade, C. Scheidlinger, 1996. Feasibility and cost-effectiveness of flood irrigation for reduction of sand motion and PM10 on Owens Dry Lake. Great Basin Unified Air Pollution Control District Report, 157 Short Street, Bishop, CA. 388 pp.
- Kavouras, I.G, V. Etyemezian, G. Nikolich, J. Gillies, M. Sweeny, M. Young, D. Shafer. 2009. A new technique for characterizing the efficacy of fugitive dust suppressants. *J. of Air & Waste Management Assoc.* 59(5): 603-612.
- Kuhns, H., J. A.Gillies, V. Etyemezian, G. Nikolich, J. King, D. Zhu, S. Uppapalli, J.

EXHIBIT 1 - OTM 30 RESPONSE
Expert Panel Final Report

- Engelbrecht, and S. Kohl, 2010. Particulate matter emissions from wheeled and tracked vehicles operating on unpaved roads. *Aerosol Science and Technology* 44: 193-202.
- Lyles, L, and B.E. Allison, 1976. The protective role of simulated standing stubble. *Trans. ASAE* 19(1): 61-64.
- Mazzetti, C., E. Todini, 2002. Development and application of the block kriging technique to rain-gauge data. Report from Project MUSIC supported by European Commission contract N EVK1-CT-2000-0058, University of Bologna, Italy.
- Ono, D., 2002. Comparative sand flux measurements using BSNE and Cox sand catchers on south sand sheet of Owens Dry Lake. CSC v BSNE (CH2M Hill South sand project 2002)-1.pdf.
- Ono, D., 2006. Application of the Gillette model for windblown dust at Owens Lake, CA. *Atmospheric Environment* 40, 3011-3021.
- Ono, D. and K. Richmond, 2009. Proposed Default K-factors Memorandum, Great Basin Unified Air Pollution Control District Report, 157 Short Street, Bishop, CA, December 2.
- Shao, Y., 2000. "Physics and Modelling of Wind Erosion." Kluwer Academic Publishers, Dordrecht.
- Zhong, S., J. Li, C.D. Whiteman, X.Bian, W. Yao, 2007. Climatology of high wind events in the Owens Valley, California. Dept. of Geography, Michigan State Univ., East Lansing, MI. on web and submitted to *Monthly Weather Review*
- Zufall, M.J., W. Dui, C.I. Davidson, 1999. Dry deposition of particles to wavy surfaces: II. wind tunnel experiments. *Atmos. Environ.* 33: 4283-4290.